



AKAI
professional



S950
MIDI DIGITAL SAMPLER

WARNING

To prevent fire or shock hazard, do not expose this appliance to rain or moisture.

WARNING

Power requirements

Power requirements for electrical equipment differ from area to area. Please ensure that your machine meets the power requirements in your area.

If in doubt, consult a qualified electrician.

120V, 60Hz for USA and Canada

220V, 50Hz for Europe except UK

240V, 50Hz for UK and Australia

What you should know to protect yourself and the Akai S950.

Watch out! You might get an electric shock

Never touch the plug with wet hands.

Always pull out by the plug and never the cord.

Only let a qualified professional repair or reassemble the Akai S950. An unauthorized person might touch the internal parts and receive a serious electric shock.

Never allow a child to put anything, especially metal, into the Akai S950.

Let's protect the Akai S950 too.

Use only a household AC power source. Never use a DC power source.

If water is spilled on the Akai S950, disconnect it and call your dealer.

Make sure that the Akai S950 is well ventilated and away from direct sunlight.

To avoid damage to the internal circuits and the external surface, keep away from heat (stoves, etc.).

Avoid using spray type insecticide near the Akai S950. It can damage the finish and might ignite suddenly.

To avoid damaging the finish, never use denaturated alcohol, paint thinner or other similar chemicals to clean the Akai S950.

Place the Akai S950 on a flat and solid surface.

To enjoy the Akai S950 for long time, please read this operator's manual thoroughly.

Should a problem persist, write down the model and serial numbers and all pertinent data regarding warranty coverage as well as a clear description of the existing trouble. Then, contact your nearest authorized Akai Service Station, or Akai Electric Co., Ltd., Quality Assurance Dept., Service Section in Tokyo, Japan.

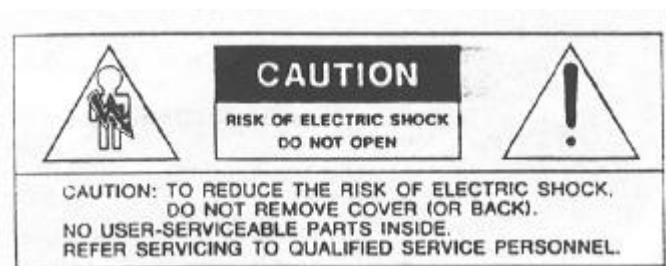

The lightning flash with the arrowhead symbol **superimposed across** a graphical representation of a person, within an equilateral triangle, is intended to alert the user to the presence of uninsulated "dangerous volts" within the product's enclosure: that may be of sufficient magnitude to constitute a risk of electric shock.



The exclamation point within an equilateral triangle is intended to alert the user to the presence of important operating and maintenance (servicing) instructions in the literature accompanying the appliance.

Precautions

FOR CUSTOMERS IN THE UK

IMPORTANT FOR YOUR SAFETY

The flex supplied with your machine will have two wires, as shown in the illustration.

TWO CORE FLEX IMPORTANT

The wires in this mains lead are coloured in accordance with the following code: Blue: Neutral Brown: Live As the colours of the wires in the mains lead of this apparatus may not correspond with the coloured markings identifying the terminals in your plug, proceed as follows: The wire which is coloured blue must be connected to the terminal which is marked with the letter N or coloured black. The wire which is coloured brown must be connected to the terminal which is marked with the letter L or coloured red.

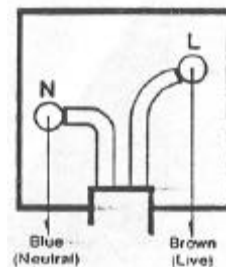

Do not connect any wire to the larger pin marked E or down when wiring a plug. Ensure that all terminals are securely tightened and that no loose strands of wire exist.

Warning -- This equipment generates and uses radio frequency energy and if not installed and used properly, that is, in strict accordance with the manufacturer's instructions, may cause interference to radio and television reception. It has been type tested and found to comply with the limits for a Class B computing device in accordance with the specifications in Subpart J of Part 15 FCC Rules, which are designed to provide reasonable protection against such interference in a residential installation. However, there is no guarantee that interference will not occur in a particular installation. If this equipment does cause interference to radio or television reception, which can be determined by turning the equipment off and on, the user is encouraged to try to correct the interference by one or more of the following measures:

Reorient the receiving antenna

Relocate the computer with respect to the receiver Move the computer away from the receiver

Plug the computer into a different outlet so that computer and receiver are on different branch circuits.

If necessary, the user should consult the dealer or an experienced radio/television technician for additional suggestions.

The user may find the following booklet prepared by the Federal Communications Commission helpful:

"How to Identify and Resolve Radio-TV Interference Problems"

This booklet is available from the U.S. Government Printing Office, Washington, DC 20402. Stock No. 004-000-00345-4.

"This digital apparatus does not exceed the Class B limits (a radio noise emissions from digital apparatus set out in the Radio Interference Regulations of the Canadian Department of Communications"

AKAI S950 SAMPLER MANUAL - INTRODUCTION

Welcome to the Akai S950 Digital Sampler. This versatile instrument provides the flexibility associated with more expensive machines yet is easy to use once you become familiar with its operation. It took many months of intensive development to produce the S950 and it will take some time and practice for you to master this advanced instrument but the reward for your efforts will be the opportunity to make creative and exciting music using the latest in sampling technology.

No-one can deny the impact sampling has had on the way we make music - it could be argued that it is as revolutionary as the invention of the synthesizer itself. The Akai S900 was the first sampler that brought affordable, studio quality sampling in an easy to use and flexible rack mounting format to many musicians and studios the world over becoming an industry standard by which all other samplers were compared. The new S950 is the successor to that sampler and combines the benefits of improved technology with all the best features and software updates of the S900 plus all those features that people wanted to see on the S900 such as higher bandwidth, expandable memory, etc.. We are sure you will enjoy using your S950 for many years.

But first, let's take care of the unit.

If the unit is going to be kept in a rack full of other equipment in a studio, it's a good idea to make sure there is some ventilation around it if you can. This can be done by leaving a 1U gap on top of the S950- which can be filled in with a blank rack panel. This will prevent any overheating of the unit. If you are going to be transporting the S950, especially if you are gagging with a band, we recommend the use of a sturdy flight case to protect your investment. Once again, if it's in a rack with other gear, leave a gap. If you don't have a flight case, you can use the box the unit came in when transporting your S950.

When you are transporting the S950, ensure that either the supplied disk protector or a blank disk is inserted in the disk drive to protect the disk drive's delicate heads.

If the unit gets dirty, you can clean it with a warm, damp cloth and some mild detergent but do not use any strong solvents or you will ruin the finish.

If your S950 develops a fault, there are no user serviceable parts inside so don't open the unit up in the unlikely event of anything going wrong. This will invalidate your warranty as well as potentially damaging the instrument further. You may also get an electric shock. Please refer the unit to your local Akai dealer who will have it repaired by an authorized repair center.

If any liquid is spilled into the instrument, turn it off at the mains supply - do not try to switch it off at the front panel as you may get an electric shock. Do not open it up to try and clean it but take it to your local Akai dealer.

Under no circumstances open the unit up if it is connected to the mains supply even if the unit is switched off as you may get an electric shock.

There are a variety of options available for the S950 which are discussed later. To fit these, please take your instrument to your local Akai dealer who will either fit them for you or will arrange for an authorized service center to fit them. Trying to fit them yourself will invalidate your warranty. Similarly, any modifications you might make to your S950 will also invalidate your warranty.

To avoid damage to the internal circuits and the casework, ensure that the S950 is kept away from heaters, radiators, stoves. etc..

Never let a child put anything, especially metal, into the S950. Also, keep children away from the polythene bag that the unit is wrapped in.

Although the S950 has been built to withstand the many rigours of the music business, it is a precision instrument that must be treated as such. Look after your new instrument and it will look after you providing you with years of reliable service.

S950 TABLE OF CONTENTS

GETTING STARTED.....	4
S950 - AN OVERVIEW.....	6
S950 - BASIC SAMPLING ARCHITECTURE.....	8
USING THE S950 - THE BASIC.....	9
GETTING ROUND THE S950.....	10
USING THIS MANUAL.....	12
ENTERING NAMES.....	13
PALY MODE - TROUBLESHOOTING.....	14
SAMPLING ON THE S950 - USING THE RECORD FUNCTION.....	16
EDIT SAMPLE.....	21
EDIT PROGRAM.....	32
MIDI FUNCTION.....	44
UTILITY MODE - PROGRAMMING THE AKAI ME35T.....	48
DISK LOADING AND SAVING - THE DISK DRIVE.....	50
MASTER TUNE.....	57
APPENDIX	
KWIKREF PROCEDURE CHART.....	61
KWIKREF OPTIMUM BANDWIDTH CHART.....	63
ADVANCE APPLICATIONS.....	65
S950 SPECIFICATIONS.....	74
S950 MIDI IMPLEMENTATION CHART.....	75
WHAT IS SAMPLING?.....	76
WHAT IS MIDI?.....	80

GETTING STARTED

You are probably impatient to hear your new sampler so let's connect it up.

Referring to Fig. 1, connect the MIDI OUT of a suitable keyboard to the MIDI IN on the S950 using a standard 5 pin DIN cord. Preferably, to take full advantage of the S950's expressive capabilities, the MIDI keyboard should have pitch bend, modulation wheels and touch sensitivity but don't worry if it hasn't. Naturally, we recommend the use of the Akai MX76 master keyboard but any MIDI controller can be used including guitar-MIDI converters, wind controllers such as the Akai EWI or EVI or a MIDI drum controller.

Now take a standard Jack-to-Jack lead from the MIX OUT socket on the rear of the S950 to the LINE input of a mixer or amplifier. If you are using a standard guitar amplifier, connect the lead to either the input on the front of the amp marked 'HI' or, better still, have a look round the back of the amp to see if there is an input marked 'AMP IN' which will bypass the amplifiers preamp and so reduce the possibility of distortion. If you are using a hi-fi amp, then you will probably need to use a hack-to-phono lead and connect the S950 to the AUX input on the amp.

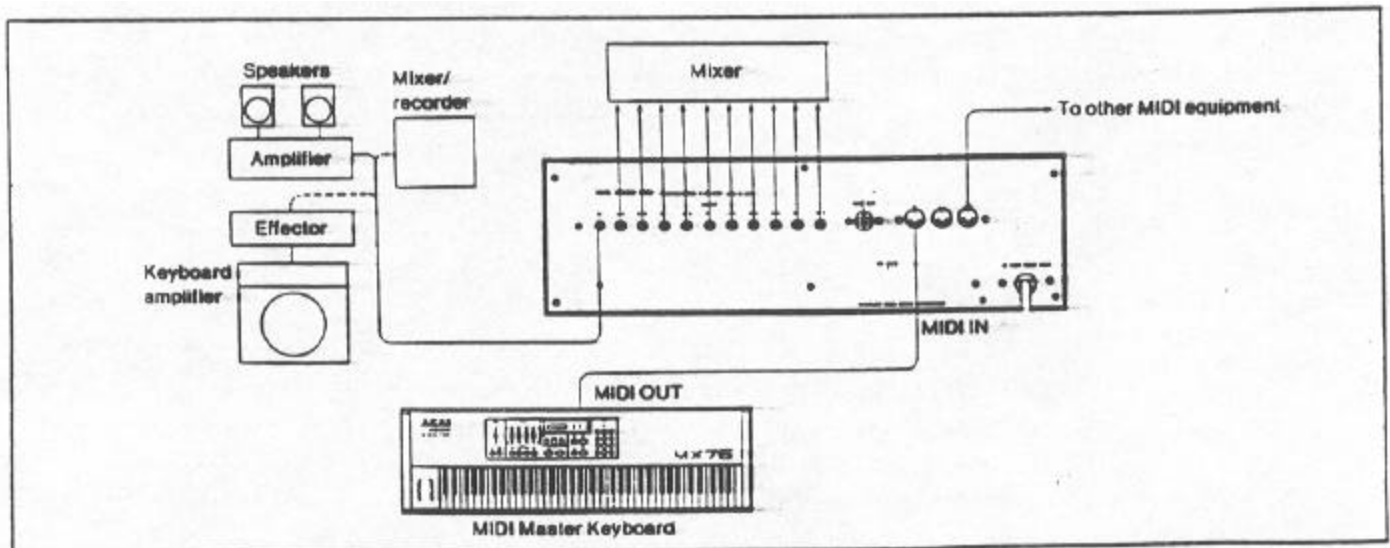

FIG. 1 Connecting the S950

Making sure that the amplifiers volume control is right down and the S950 is switched off, insert one of the disks supplied with the S950 with the label facing upwards. Push gently until the disk locks in place - the push tab will pop out from below the disk drive when it has been properly inserted. Now turn the S950's power on - the disk will automatically load. While that is happening, you may like to adjust the contrast control to the left of the display for the most legible display.

This should take around 40 seconds depending on how much data is on the disk and the red light on the disk drive will be lit and you will hear some clunking and whirring noises from the S950 as the disk contents are loaded. This is normal so don't worry!!

CAUTION: UNDER NO CIRCUMSTANCES MUST YOU REMOVE THE DISK WHILE THE RED LIGHT IS ON AS YOU MAY DAMAGE THE DISK OR THE DRIVE. NEITHER MUST YOU TURN THE S950'S POWER OFF WHILST A DISK IS LOADING.

After the disk has loaded, you are ready to play your S950 so turn up the volume on the amplifier and play a few notes on the keyboard - you should now hear a sound. To see what other sounds are in the S950, simply turn the grey CONTROL wheel anticlockwise to scroll through the programs. When you want to change the sound, simply type in the appropriate number using the blue keypad. Repeat that process to select the other sounds.

Once you've heard all the programs on that disk, you can select another disk so turn the amplifier volume down, take out the first disk you put in by pressing the push tab below the disk drive and switch the S950 off.

Now insert another disk as described above and turn the samplers power back on. After 40 seconds of more clanking and whirring, turn up the amplifiers volume because you are ready to listen to the sounds on the second disk scrolling through the different programs using the data wheel as described above and selecting different programs by typing in the relevant program number. You can repeat this whole procedure for the remaining two disks.

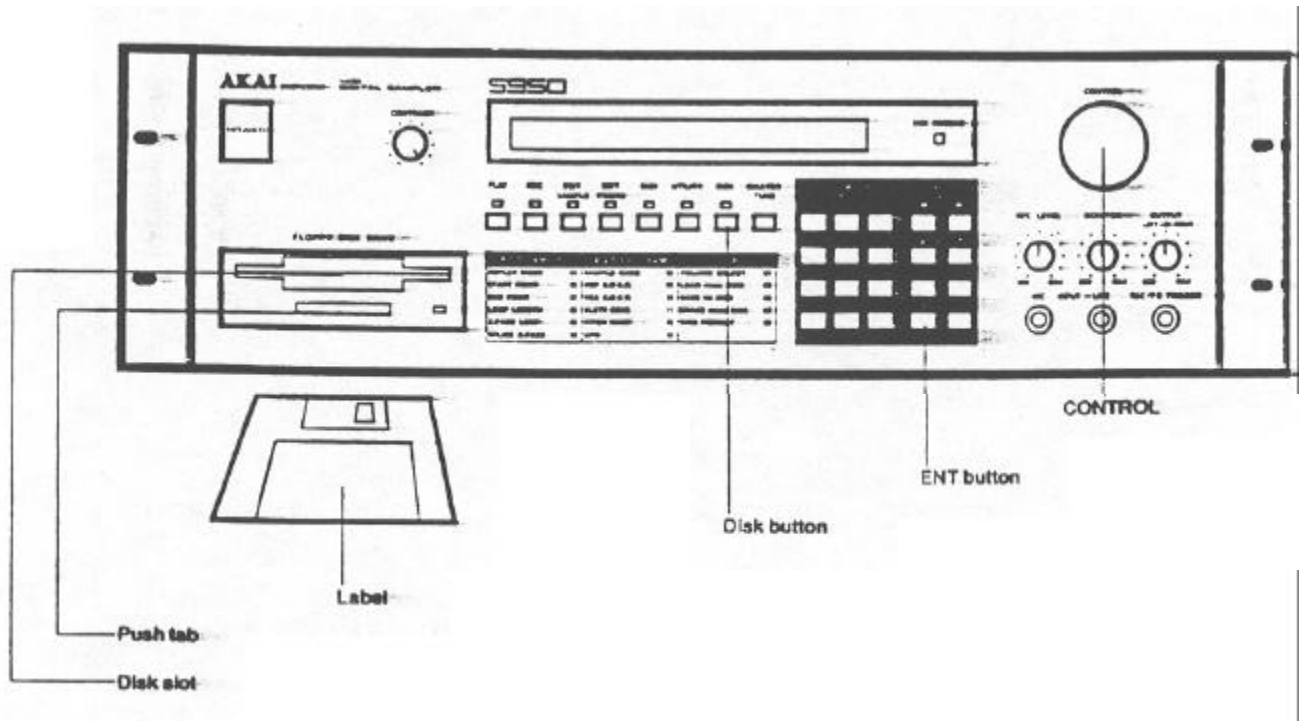

S950 - AN OVERVIEW

The S950 is a digital sampler that has 16-bit processing and 12-bit sampling with a maximum sampling rate of 48kHz. As well as allowing you to use any of the large library of S900 sounds you can also use sounds from the S1000 sample library and double density or high density disks can be used for storing samples. The S950 enables you to sample and play sounds with astonishing clarity and dynamic range and because the bandwidth is variable up to 19.2kHz, you can be sure that high frequencies are faithfully reproduced.

The basic memory is 750K (which is expandable to 2.25Meg) and the basic sampling time is variable between over a minute at reduced bandwidth to ,lust over nine seconds at full bandwidth. Furthermore, bandwidth is totally variable allowing you to squeeze as much sampling time as possible out of your S950.

The S950 also has 8 individual monophonic audio outputs which can be used with drums. and percussion and other instruments for separate processing, EQ and balancing of individual sounds on a mixer. There are also left and right outputs for pseudo stereo effects.

The maximum number of samples you can have in memory at ones is 99 but that depends on how long the samples are of course. You can also have as many as 198 programs.

No sampler would be complete without extensive editing facilities and the S950 is no exception. As-well as the usual looping facilities, the S950 has an effective AUTOLOOP facility to take the drudgery out of looping and it also has CROSSFADE LOOPING for obtaining smooth, glitchless loops. There are also splicing facilities for merging two or more samples together and double speed MIDI increases the communication speed of sample dumping over MIDI which is invaluable if you feel the need to use a computer for visual editing of samples.

There are- also extensive program editing facilities such as envelope shaping, filtering; pitch sweep and LFO effects as well as a two positional velocity switch function and positional crossfade functions.

Several new features include a 'load while play' function on the disk drive so that you can be loading new sounds from disk whilst you play. The S950 is also the first sampler in its price range to feature TIMESTRETCH which enables you to lengthen or shorten a sample by as much as 999% without any change in pitch.

Other features include PRETRIGGER RECORDING which allows you to sample sounds without losing the all important initial attack transients and the AUTOMATIC LOCATING OF START POINT function allows easier editing of a samples start point.

Several options are also available for the S950 including an ATARI/SUPRA and CD/DAT INTERFACE BOARD (IB105) which allows larger storage and faster disk access and also enables sampling to and from a CD or RDATE machine for increased audio fidelity. The internal memory can also be increased using up to two MEMORY EXPANSION BOARDS (EXM006) which allow maximum internal memory capacity of 2.25 Meg giving you a maximum sampling time of nearly 30 seconds at full bandwidth and over three minutes of sampling at the lowest bandwidth setting.

The most important thing about the S950 is that, despite the incredible versatility of the instrument, it is very easy to use and won't interfere with your music making. Naturally, you would rather play with your new instrument than read a manual but please, read the manual sometime. Even if you've been an S900 user for some time, there is still information in here which will be new to you and there may even be a few surprises.

S9500 - BASIC SAMPLING ARCHITECTURE

Before we explore the workings of the S950, let us first see how it functions as there are a few things you need to know about which will make your understanding of the instrument a lot clearer.

There are basically two things you can have in the S950 - SAMPLES and PROGRAMS. A sample is a digital recording of a sound. The sound can be anything from a car crash to a flute. Once you have a sample or a collection of samples in the S950, you want to be able to play it from the keyboard (or any other MIDI controller such as a MIDI drum, guitar or wind controller or a MIDI sequencer). To do this, the sample<s> must be placed in KEYGROUPS and these allow you to map the sample out across the keyboard within a PROGRAM.

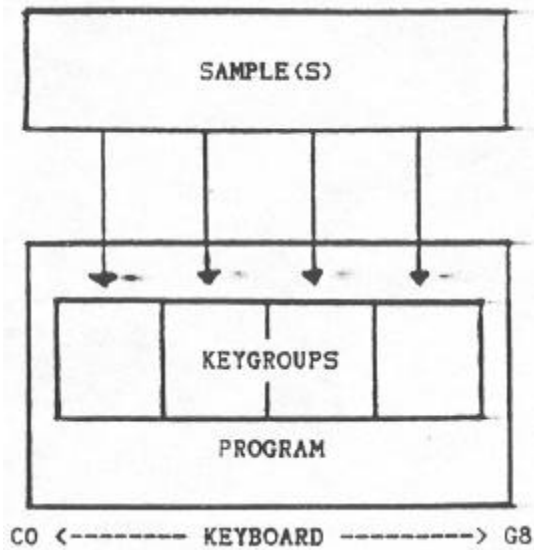

FIG. 1 Basic sampling architecture of the S950 - samples into keygroups mapped out across the keyboard range within a program

The simplest program you can create is to have one sample that spans the entire keyboard range. Alternatively, you could assign that one sample to just one key or you could have any number of keygroups assigned to individual keys with separate samples in each of them. You could also have a program which uses two samples, one spanning the bottom two octaves, the other spanning the top three octaves. It is also possible to have two samples in one keygroup each of which are sounded using keyboard dynamics where soft keystrokes play the one sample and hard keystrokes play the other - this is known as VELOCITY SWITCHING.

Having done that, each keygroup can have its own envelope shaping, filtering, fine tuning, vibrato and pitch sweep effects, individual output assignment and each keygroup can have its own MIDI channel and even the simplest sample can be radically transformed within a program. Furthermore, because any changes made to an individual samples keygroup within a program do not affect the actual sample data itself but are only sound processing functions, you can have many, many variations of one sample to create an even greater range of sounds which can be recalled at the touch of a button.

But, how does all this work? Let's find out.

USING THE S950 - THE BASICS

There are 8 basic modes on the S950 which are selected using the 8 buttons that run underneath the display. These are PLAY, REC, EDIT SAMPLE, EDIT PROGRAM, MIDI, UTILITY, DISK and MASTER TUNE. These are all fairly self explanatory and their basic functions are as follows:

PLAY - This selects the program you wish to play. Different programs can be viewed using the large grey CONTROL wheel and selected by typing in the appropriate number on the blue keypad. Alternatively, programs can be recalled via MIDI from the connected MIDI keyboard.

REC - This is where you do your sampling. There are a number of 'pages' in this mode which you can scroll through using either the CONTROL wheel, the keypad or the PAGE UP/DOWN buttons to the right of the blue keypad. In this mode you can name a sample, set sampling time and bandwidth and set the key onto which the sample is to be recorded.

EDIT SAMPLE - This also has a number of pages which are similarly selected using the CONTROL wheel, the keypad or the page up/down buttons. This is the mode where you can tune a sample, edit the start and end of a sample, reverse the sample, loop a sample, splice two samples together and stretch or compress samples. In this mode, also, you can copy, delete and rename samples.

EDIT PROGRAM - This is the mode in which you can map out your samples across the keyboard as well as add envelope shaping, filtering and fine tuning. You can also add a special pitch sweep feature called WARP and, in this mode, you can set things like LFO, MIDI channels, individual output assignments, etc.. You can also copy, rename and delete programs. This mode, too, has a number of pages which are selected as above.

MIDI - As you would imagine, this allows you to set the 'global' MIDI parameters of the S950 such as its basic receive channel, pitch bend and other MIDI related parameters.

UTILITY - This allows you to program an Akai ME35T audio/drum pad-MIDI converter for triggering samples.

DISK - This allows you to select different disk drive operations such as loading and saving.

MASTER TUNE - This allows you to fine tune the S950 to other instruments.

The other controls on the front panel of the S950 include the large grey CONTROL knob. This is used for a variety of purposes depending what mode you are in. It can be used to scroll through displayed programs or it can select pages in the different modes. It can also be used for data entry and for naming samples and programs.

There is also a large 0-9 keypad which can be used to input data whilst the 8 buttons to the right of the keypad enable you to move the cursor around the screen using the ARROW/CURSOR < and > buttons, to select pages using the PAGE UP/DOWN buttons. There are two ON/OFF buttons which also double as +/- keys for certain applications and there are two keys to allow you to name samples and programs. Finally there is the ENT button which is used to enter data and the PB or 'playback' button which can be used to play back a sample without the need to use a MIDI keyboard or controller.

GETTING ROUND THE S950

Behind the deceptively simple control panel of the S950 lies a wealth of features. As we have seen, the main functions of the S950 are accessed simply by pressing the required button. After that, each mode (with the exception of PLAY and MASTER TUNE) have a number of 'pages' or sub-modes which give you access to further functions.

Accessing any of these pages is simple: select any of the page driven modes you wish to work in (i.e. REC, EDIT SAMPLE, EDIT PROGRAM, MIDI, etc.) by pressing the appropriate button underneath the main LCD display. To go to another page, you can either press the PAGE DOWN button located to the right of the blue keypad or you can scroll through the pages using the CONTROL knob. In EDIT SAMPLE, EDIT PROGRAM, MIDI, UTILITY and DISK, because the pages are actually numbered, when the cursor is in the top left hand corner of the LCD display (i.e. flashing on the page number), you can type in a two digit number on the blue numeric keypad which will take you straight to the page you wish to work on. To further help you with this type of page access, there is a chart underneath the mode buttons which list the most commonly used pages in EDIT SAMPLE, EDIT PROGRAM and DISK. As you become more familiar with the S950, you will be skipping back and forth between pages almost instinctively.

To further help you with programming and editing, there is a button marked 'Space' to the right of the keypad. This has two functions. In the 'letter' mode, it is used to enter a space into a name (see ENTERING NAMES) but, when you are in any of the main modes of operation it allows you to switch between two positions very quickly. This is done by going to a page-in any of the modes and making some form of data entry.' Now move to another page and make another data entry. By pressing the space button, you will be taken back to where you made your first data entry and pressing the space button again will take you to the place where you made your second data entry.

Data entry in all modes can be made in any number of ways. Some functions require a numeric input - this can be done using the CONTROL knob or the blue 0-9 keypad. Some functions allow only keypad entry of data whilst others require that you use the ON(+)/OFF(-) buttons. To get to any of the data entry fields in any of the pages, you use the CURSOR > button located to the top right next to the keypad to move -left to right across the LCD display. You can also use the CURSOR < button to move back a field (i.e. right to left). When you are in the field in which you want to make your change, you enter data using any of the methods described above.

Don't worry if this all seems complicated as this manual will take you through these functions step by step and soon you will discover how easy it is to create your own samples and programs on the S950.

Of course, there's more to it than that and so we will take you through each mode, control and function in greater detail so that by the time you have read through all this, you will have a greater insight to the fantastic creative possibilities offered to you by the S950.

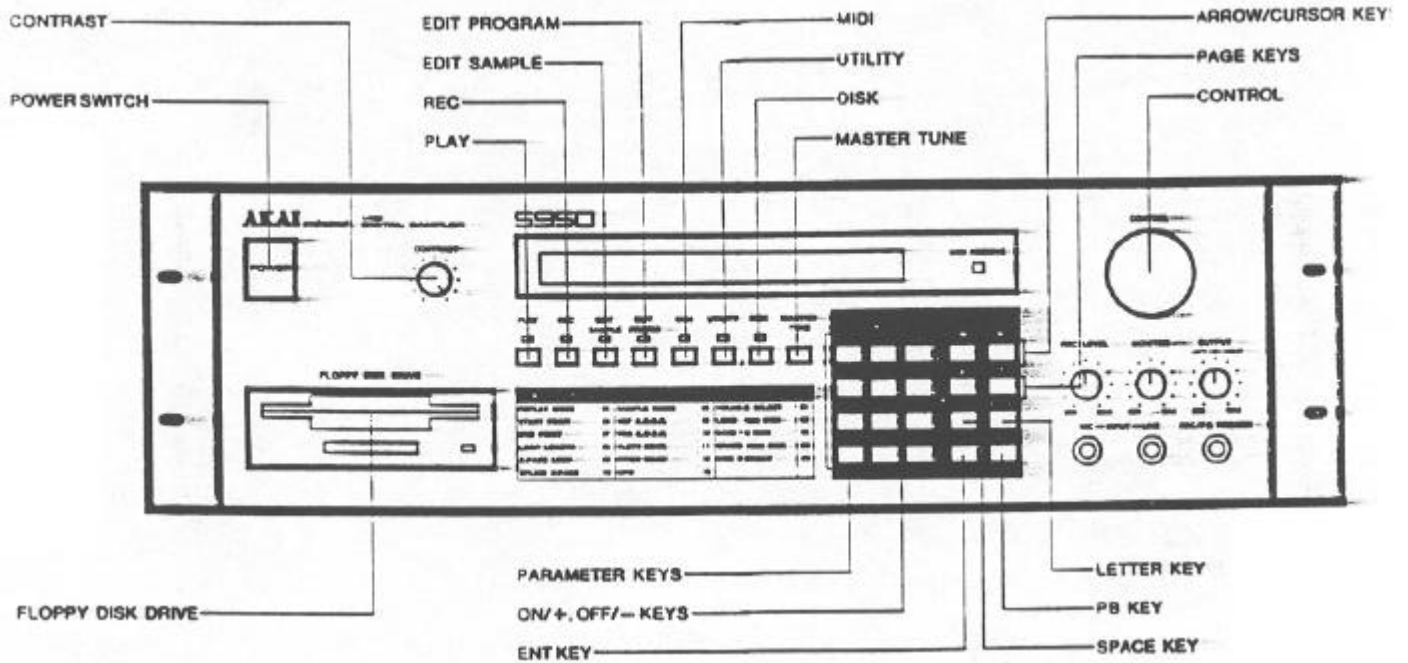

USING THIS-MANUAL

This manual has been written to provide you with all the information you need to fully exploit the facilities on your S950. The sections are not dealt with in any operational order but deal with the eight basic modes of operation as the buttons appear from left to right. Of course, this may not necessarily be the order in which you wish to use the S950 so simply refer to the mode you wish to learn about.

At the end of the manual are 'KWIKREF' charts. One is summarized step by step guide to using the most commonly used pages in the various modes for quick and--easy reference, the other is a guide to optimum bandwidth settings for sampling. There is also an ADVANCED APPLICATIONS GUIDE for more advanced uses of S950 functions. For newcomers to the exciting world of sampling and MIDI, there are also brief explanations of these principles.

Let us now look at the various modes of the S950 and their respective functions.

ENTERING NAMES

You will need to name samples and programs when you begin to create your own sounds. The S950 allows you to name sounds of up to 10 upper case characters using all letters in the alphabet. Numbers 0-9 can be used in a name as well and you can also include certain symbols such as #, + and -. It is also possible to insert spaces in a name.

You will need to name a sound in the REC mode (i.e. when you create a new sample), in EDIT-SAMPLE and in EDIT PROGRAM. In the REC mode, you must give a new sample a new name otherwise the original sample will be overwritten. In EDIT PROGRAM, you will need to copy an existing program to use as the basis of a new program so you will need to enter a new name in this mode as well. It is only in EDIT SAMPLE that the need to write new names is not so necessary as the sample name is usually defined in the REC mode. Having said that, it is often desirable to rename a sample.

So, how do you enter names on the S950.

You will notice that there is a button to the right of the keypad called 'Letter'. Pressing this button turns the S950 into a simple typewriter and you then use the CONTROL knob to scroll through the alphabet. The CONTROL knob also gives you access to the numbers 1 to 9 although numbers are more easily entered using the blue numeric keypad. You can also enter a space in the name using the CONTROL wheel but there is also a button marked 'Space' which does this more easily. You can also use the two buttons marked ON(+) and OFF(-) to enter + and ° signs whilst the CONTROL knob allows you to enter a # symbol as well.

To enter a name in any of the above modes, you hit the 'Letter' button and choose the first character of your name as described above. You then hit the CURSOR > button to advance the cursor to the next character where you select your new character. Press the CURSOR right button again to move to the next character and choose a new character and repeat this whole process until you have entered the name you have chosen. When you have done this, hit the ENT button to enter the name into the S950's memory.

If, at any time, you make a mistake, you can backstep through the name using the CURSOR < button and change the character.

PLAY MODE

This is probably the easiest mode to get to know and as good a point to start as any. Basically, it is the mode where you can see what programs-are in the S950 and it is where you can select any one of them.

To view all the programs, simply turn the large grey CONTROL wheel - this is called 'scrolling' and will effectively move the programs in memory across the display. You can now select the required program by typing in a number on the blue keypad or via MIDI. When you select a program, the program is shifted to the far left of the display and the cursor flashes at the selected program somber.

If there are more than 9 programs in memory, the display will prompt you to type in a two digit number, even if the program you wish to select is numbered less than 10. For example, if you want to select program 4, type in 04 and if you want to hear program 13, type in 13 - it's as simple as that If your S950 has less than 10 programs you only need to type in the one digit.

If you wish to select programs from your keyboard using MIDI, simply press the required program number on the MIDI keyboard. For example, if you want to hear program 12, press memory location button 12 on the keyboard's front panel. All being well, program 12 will be automatically selected on the S950 on the screen.. Naturally, if you select program 64 on your keyboard but there aren't 64 programs in the S950, nothing will happen. and the S950 will stay on the last selected program.

Note: It is possible to glue a program any MIDI program number you wish In EDIT PROGRAM. In other words, even though a program may be number 3 on the S950's display, It !s possible to assign a MIDI program number of 46 to that program so that recalling program number 46 on. the MIDI controller will call up program 3 on the S950. For further information refer to EDIT PROGRAM.

TROUBLESHOOTING

There can be occasions where something you do on the S950 does not select the required program. This can be for a number of reasons.

For example, it could be that you have ten or more programs in memory and you only typed in a one digit number in which case the S950 will stay on the last selected program.

It could be that you select a program correctly but there is no sound. This can be for a number of reasons. Firstly, the S950 may be switched to MIDI OMNI OFF and the program itself may be on a different MIDI channel to the one you have selected on the keyboard. To get round this problem, you can either press MIDI on the S950 and switch OMNI to ON so that the S950 responds to all channels (for more information refer to MIDI FUNCTIONS) or you could change the transmitting channel on your keyboard. Alternatively, you could edit the programs MIDI channel in EDIT PROGRAM (for more information see EDIT PROGRAM).

It may be that selecting a different program number on your keyboard has no effect on the S950. This can be for two reasons. Firstly, your synths ability to transmit program change information has been switched off. Alternatively, the S950 has been set not to respond to program changes in the MIDI mode. In' either case, switch the program change facility on the controlling keyboard or the S950 to ON (please refer to the section MIDI FUNCTIONS to find out how to do this on the S950).

Another reason for this is that the program has been assigned a different MIDI program number in EDIT PROGRAM (see above). To change this, please refer to EDIT PROGRAM.

Finally, if everything has been set up correctly but you are still not getting a sound, please check the following:

Is the audio lead from the S950 to the amplifier or mixer alright?

Is the amplifier volume turned up - is the amplifier actually turned on!! It can happen, even to professionals!! Alternatively, if you are using a mixer, is the mixer channel fader up or is the correct mixer channel fader up? Are the master faders up?

Is the MIDI keyboard switched on and is the MIDI lead connected properly? Is the MIDI lead broken? If the MIDI keyboard and the MIDI connections are working properly, the little red MIDI monitor LED to the right of the main display on the S950 will light whenever !t receives any MIDI.

Does your keyboard transmit MIDI volume controller number 07? If it does, it could be that it has been inadvertently turned down which has remotely turned the S950's volume down. If this is the case, you will have to turn the keyboards MIDI volume control up (*note: this is not to be confused with the keyboards master volume control - MIDI volume will more then likely be present on the controlling keyboards date entry slider*). Once you have done this, go to the MIDI function on the S950 and turn the function marked VOLUME to OFF to prevent it happening again (please refer to MIDI FUNCTIONS).

And if all this is beginning to sound difficult, don't worry as we shall take you through all these other functions very soon. Besides, if you are only using the disks supplied with the S950 and loading them as described in GETTING STARTED, you shouldn't be experiencing any of these problems.

SAMPLING ON THE S950 - USING THE RECORD FUNCTION

This is the mode where you actually sample your own sounds into the S950. Many people are frightened by the process of sampling but it is not very difficult as you shall see.

To sample on the S950, plug either a microphone into the MIC input or, if you are using a line level signal such as a synthesizer, another sampler, a tape or cassette deck or electric guitar, use the LINE Input. Now press the button marked 'REC'.

The first page you have when you press REC displays:

NAME OF SAMPLE TO BE RECORDED

If there are no samples in the S950 the display will read:

NAME OF SAMPLE TO BE RECORDED
TONE

If other samples are present, the display could read any one of those sample names:

When you are sampling, you must always give the new sample a new name that is different from any other samples name currently in memory. Failure to do this will result in existing samples being overwritten.

To name a sample, press the button marked 'LETTER' which is to the right of the blue keypad. You can now enter a name for your new sample scrolling through the alphabet and numbers 1-9 using the grey CONTROL knob. Spaces can be inserted using the SPACE button to the right of the keypad and you can also use '+' and '-' characters in a name by pressing the ON(+) and OFF(-) buttons. When you have done that, hit the button marked 'ENT' next to the blue keypad to enter the new samples name.

Note: It is good practice to include useful Information in a samples name such as the pitch of the sample or, if it's one sample of several similar samples, to give a numeric value. An example would be: VOICE 1 C3 or PIAN04 F2. In this way, when you are editing a sample, you know exactly what it is.

Now move to the next page by pressing the page down button found to the right of the blue keypad. The display will read:

NAME OF SAMPLE TO BE MONITORED
Monitor

This page allows you to hear the sound you are sampling through the MONO MIX output on the back of the S950. It is also possible to monitor the new sample in context with an existing program. This will be covered in more detail in the ADVANCED APPLICATIONS section.

Now go to the next page pressing the page down button. This will display:

AUDIO SOURCE: Analog input
(1),
Digital fibre optic (2), Phono (3) #

where '#' Indicates the current input source selection.

The default setting for this page is 1 - Analogue input (i. e. the MIC or LINE input socket on the front panel of the S950). If you are using the IBI05 HARD DISK/CD DAT INTERFACE board, you can select 2 or 3 which will allow you to sample directly from the CD or RDATE's digital or fibre optic output (please refer to the IBI05 documentation for information on this).

Using the 'page down' button, go to the next page which will read:

```
DIGITAL AUDIO
CD 44kHz (1), DAT 32kHz (2), 48kHz (3) #
```

where '#' is the current selection.

These parameters relate entirely to the IBI05 option so please refer to the interface's documentation for more information on using this page.

Now move to the next page using the page down button. The display will read:

```
AUDIO BANDWIDTH (3000Hz to 19,000Hz)  ##,###
```

where '##,###' is the selected bandwidth.

Here you can set the bandwidth for the sound you are about to sample. You can enter a number directly from the keypad by typing a 5 digit number or you can use the CONTROL knob although this is a lot slower. Higher bandwidth settings will give the sound better high frequency response and the sound will be brighter but this also takes up more memory than lower bandwidth settings. To conserve memory, use the minimum bandwidth necessary for an acceptable sound quality. You may like to refer to the OPTIMUM BANDWIDTH 'KWIKREF' chart at the back of the manual for a guide to particular instruments optimum bandwidth.

Having set the bandwidth to your requirements, press ENT to enter the data. Now move to the next page where the display will read:

```
RECORDING TIME (250mS to ##,###mS) ^^,^^mS
```

where ##,### is the maximum sampling time allowed by the remaining memory and where ^^,^^ is the currently selected amount.

Note: the maximum sampling time available (##,###) depends on the bandwidth selected in the previous page and on how much memory has already been used for other samples.

To set the sampling time, enter a 5 digit number using the keypad and press ENT. You can also use the CONTROL knob but, again, this is a lot slower. Use the minimum time possible to capture the whole of the sound you wish to sample.

Note: if you have the memory expansion board fitted, it is possible to enter a 6 digit number as the maximum sampling available is much larger.

Once you have entered your sampling time, you can move to the next page. This will read:

```
PITCH OF SOUND BEING RECORDED:  ##
```

where ## is the currently selected value (the default value is C3).

You can now change this parameter if you wish by simply pressing the appropriate note on the connected MIDI keyboard or controller. You can also use the CONTROL knob but keypad entry is not possible.

When you have done this, go to the next page which will read:

START SAMPLING WITH - Any key (1)
Footswitch (2), Audio level (3)

where # indicates the current selection (default is 3).

Here you can use the keypad to enter a number as follows:

- 1 = sampling begins when you hit any key on the keypad.
- 2 = sampling begins when you press a footswitch connected to the S950's REC/PB footswitch input on the front panel.
- 3 = sampling begins when the incoming signal exceeds a threshold level set on the next page.

The most commonly used mode is 3 - Audio level and, as the default is set for this, you do not normally need to change anything so you can go to the next page which will read:

KNOB SETS TRIG LEVEL. ANY KEY WHEN READY
T

In this page, the lower half of the display now serves as a bar-graph input level meter to indicate the incoming signal level. The 'T' is the THRESHOLD level and is set using the CONTROL knob. The idea is to set the threshold relatively low so that, as soon the incoming signal exceeds the level set by the 'T', sampling begins but be careful not to set it too low so that sampling is falsely initiated by background noise or whatever. Similarly, do not set it too high as you may miss part of the sounds attack, especially if the sound has a slow attack.

You must now set the record level. To do this, play the sound you wish to sample and adjust the REC LEVEL control on the front panel. You ideally want to set it so that the bar-graph display is just touching the series of dots in the bottom right of the display. These dots indicate overload and driving the signal too far into this region of the display will cause distortion.

To hear the incoming signal, adjust the MONITOR LEVEL control on the front panel. (NOTE: YOU WILL ONLY HEAR THE INCOMING SIGNAL THROUGH THE S950 IF THE MONO MIX OUTPUT IS USED.)

Once you are satisfied with the incoming signal level, hit any key on the blue keypad and play the sample. As soon as signal level exceeds the threshold, sampling will begin. When you do this the display will change. The top half of the display will be filled with arrows as sampling time elapses. Note that the 'T' also changes to a '#'. Once the sampling is completed, you will be returned to the above display.

You can now play the sample by playing a note on the connected MIDI keyboard or controller. If you don't have a keyboard or controller connected, you can go to the next page which will display:

HIT ENT TO PLAY

and pressing ENT will cause the sample to sound for its entire duration.

You have just successfully sampled a sound.

You will have noticed from all this that most of the pages are set up with the most sensible option as the default setting. You always have to give a new sample a new name but, apart from that, the only main things you will probably need to change are bandwidth, sampling time and the pitch at which the sample is to be recorded. In this way, you can sample your own sounds quickly and easily, often ignoring many of the pages.

TROUBLESHOOTING

There isn't much that can go wrong when in the REC mode but anything is possible!

For example, it could be that you do not get any level from the sound you wish to sample when you adjust the S950's record level control. This could be for a number of reasons.

1. Check that the input source on the S950 is correctly set. If you are using the MIC or LINE inputs, make sure that you are not switched to '2' (Fibre optic) or '3' (Phono) but that the display reads '1' (Analog).
2. Is the lead connected to the mic or line input alright? Change it if in doubt.
3. Is the microphone switched on or is the volume from your line level sound source turned up?
4. Is the REC LEVEL control up?

It might also be possible that you cannot monitor the incoming signal through the S950. This could also be for a number of reasons.

1. You can only monitor the incoming signal through the MONO MIX output. You will not be able to monitor anything if you are using either the LEFT, RIGHT or INDIVIDUAL outputs.
2. Is the MONITOR LEVEL control up? Is the amplifier on or turned up or are the mixers channel or master faders up?

Once you've sampled a sound, you may find that it is not playing back properly or even at all. If this is so:

1. Check that the MIDI keyboard or controller is connected properly and that the MIDI lead is o. k. Also check that it is on the same MIDI channel as the S950 (see TROUBLE SHOOTING In PLAY).
2. Check that the output audio from the S950 lead is alright and that the amplifier and/or mixer is working properly.
3. If the sound is muffled, check that the bandwidth was set sufficiently high before you sampled the sound. If it wasn't high enough, change the bandwidth and resample the sound.
4. If the sound is at all clipped or too short, check that the sampling time was set sufficiently long enough.

5. If the sound is distorted, check that it wasn't overloading the S950. This can be done by returning to the functions that dealt with level setting and play the original sound again to check levels.

6. If 5 checks out o. k., !s the S950 overloading the mixer and/or amplifier or is the amp overloading the speakers? Of course, to check for distortion, remove any effects such as EQ, echo or reverb that may be present on the mixer and/or amplifier.

All being well, you should not experience any of these problems and so you can now edit the sample you have dust taken.

EDIT SAMPLE

The next button along is marked EDIT SAMPLE and, not surprisingly, this is the mode in which you edit your samples and where you can change the start and end points of a sample, reverse the sample, loop the sample, splice two samples together and compress or stretch a sample. You can also copy, rename and delete a sample as well as tune a sample and change its basic pitch. This is all accomplished using a page driven system as in the REC mode.

The first page you encounter when you press EDIT SAMPLE reads:

```
>01 #Select. Copy #####  
SAMPLE #Rename, Delete (-) #####
```

where ##### is the currently selected sample name.

This page allows four options and you can select a sample for editing, copy a sample, rename a sample and delete a sample.

To select a sample, press the 'cursor >' button (found to the right of the blue keypad) once so that the cursor is flashing on the top line on the first letter of the sample name. Using the grey CONTROL knob, you can scroll through the samples present in the S950's memory. Once you have found the sample you wish to edit, press ENT.

To copy a sample the cursor must be at the same place as above and all you need to do is press the LETTER button and name a sound as described in REC and ENTERING A NAME. Once this has been done, press ENT.

To rename a sample, select the sample to be renamed as described above and press ENT then, by pressing the 'cursor >' button once, move the cursor so that it is flashing on the first character of the sample displayed on the bottom line of the LCD display (this should be the same as the sample name in the top line). Now press LETTER and give the sample its new name as described above. When you have done that, press ENT and the top line will change to display the new samples name.

To delete a sample, making sure the cursor is on the top line; first select the sample to be deleted and press ENT. Now move the cursor to the bottom line using the 'cursor >' button and press the '-' button followed by ENT. This will delete the currently selected sample from memory. *(Note that this procedure is destructive and unless you have saved the sample to disk, this sample will be lost forever. We suggest that, unless you are absolutely positive about deleting the sample, you save it to disk before deleting it from the S950's memory just in case.)*

You can now move to the next page using the 'page down' buttons. The next page will display:

```
>02 Select program Monitor
```

This is the same as the page we found in the REC mode and it allows you to monitor either the sample directly or in context with a program. The most common mode is 'monitor' but, if you want to edit the currently selected sample in conjunction with the program in which it is placed, press the 'cursor >' button to move the cursor one position and scroll through the programs using the CONTROL wheel (refer to the ADVANCED APPLICATIONS GUIDE for more information on this).

Move to the next page using the 'page down' button. It will display:

```
>03 #Loudness #Nom pitch #Fine pitch
      +00      C3 60      +00
```

This page allows you to adjust a samples level, its basic pitch and its fine tuning.

LOUDNESS: This is where you can adjust the level of the sample so that it matches the level of other samples taken. To change the value, move the cursor one position using the 'cursor >' button so that the cursor is flashing on the + character and use either the CONTROL to enter a new value or type in a + or - value using the ON(+) or OFF(-) key in conjunction with the keypad.

Note: This value is a velocity based parameter. If you set the value to +50, there will be no change in level with varying velocity dynamics. Similarly, with the setting at -50, velocity dynamics will be extreme... Note also that these values do not represent dBs but are purely an arbitrary volume unit.

NOM PITCH: This value was set in REC and represents the note on which the sample was placed in REC. To change it, move the cursor one position to the right using the 'cursor >' button so that it is flashing on the first character and use the CONTROL knob to raise or lower the pitch in semitones. You can also use the keypad for data entry here.

Note: If you are using the PB button to playback the sample, a higher note number will actually produce a lower pitched sound and vice versa. This is because as the sample gets higher in pitch, the PB button sends out the same note (C3) and so the sample will actually get lower in pitch.

FINE PITCH: This is used to fine tune samples and can be effective if you are taking a lot of samples from instrument such as piano so that you can ensure that all samples are in tune with each other. To fine tune your sample, move the cursor so that it is flashing in this field using the 'cursor >' button and change the data using the CONTROL knob or a + or -value using the ON(+) or OFF(-) buttons and a numeric entry on the blue keypad.

The next page will display:

```
>04 #REPLAY MODE One shot (1)
      Looping (2), Alternating (3) #
```

where # is the current selection (default for new sample is 1).

A sample may be played back in three ways. ONE SHOT plays the sample from start to finish and will then stop. LOOPING will play the sample from start to finish and will then repeat a part of the sample as set on Page 8 for as long as a note is held down on the keyboard. ALTERNATING is similar to LOOPING except that the looped portion of the sound will play back from beginning to end and then from end to beginning - this can be useful with rich, ensemble sounds where there will sometimes be glitching. This backwards/ forwards looping can help to smooth them out. In both loop modes, the loop length can be as long as the entire sample or as short as one single cycle of the waveform. For more information on looping, see the section ABOUT LOOPING later on. in this section.

To select the mode, move the cursor one position right using the 'cursor >' button and make your selection using the CONTROL knob or the keypad.

Now go to the next page using the 'page down' button. This will display:

```
>05  #TIME DIRECTION
      Normal (1), Reverse (2) #
```

where # is the current setting (default is 1).

This page allows you to set whether the sound is played normally or backwards. Try setting it to '2' to hear the sound reversed. To do this, press the 'cursor >' button once and then press 2 on the keypad.

Now go to the next page by pressing the 'page down' button. It will read:

```
>06  START POINT      #Coarse #Fine   #AUTO
      ( 0 - ##,###)      0,000     01
```

where ##,### is the maximum position to which the start point can be adjusted.

This page allows you to edit where the sample begins its playback.

Sometimes, it is desirable to remove part of the front of a sample. This can be due to unwanted noises or too slow an attack or possibly a delay between the time when the sampling was initiated and the time the sound was sampled. To change the start point, move the cursor one position to the right using the 'cursor >' button. It should be flashing on the first character displayed under 'Coarse'. By moving the CONTROL knob, adjust this value and, by playing a repeated notes on the keyboard as you make your adjustment, listen to the results - you will hear the attack being removed with higher settings. The next field, 'Fine' which can be selected by moving the cursor one position to the right using the 'cursor >' button is for fine adjustment of the start time. In both coarse and fine fields, the data can be input using the CONTROL knob or the keypad.

The AUTO field enables the S950 to automatically search for the start point of a sample and the numeric value represents the signal level threshold of the start point. To use the AUTO function, simply move the cursor to the AUTO field, enter the start point level you wish the S950 to search for (01 is the default and will find the lowest start point signal level whilst setting 99 will search for the highest start point signal level) and press the ENT button.

Assuming you have edited the start point to your satisfaction (remember, however, that it is not obligatory to change the start point - if the sample sounds good, leave it alone), you can now move to the next page which will reads

```
>07  END POINT      #Coarse #Fine
      (000,100-###,###)      0,000
```

where ###,### is the maximum position to which the end point can be adjusted.

This is very much the same as page 6 except that here you can edit the end of a sample. This can be useful in getting rid of any noise that may be present at the end of a sample as well as being useful for saving memory. The 'Coarse' field allows you to cutoff the end of the sample in large increments whilst the 'Fine' field allows finer settings of this value.

To edit the end point, move the cursor to the 'Coarse' field and, playing repented notes on the keyboard, try editing the end point and listen to the results. You will hear the sample getting shorter and shorter as you decrease the numeric value. Again, data entry can be via the CONTROL knob or the keypad. For finer resolution of end point editing move the cursor to the 'Fine' field and make your adjustments in the usual way using the CONTROL knob or the keypad.

Before we move to the next pages, we must first discuss some of the intricacies of looping.

ABOUT LOOPING

Because any sample you take on the S950 only lasts a finite amount of time, there will be occasions where you want to sustain that sound longer than the actual sample - this is especially true if the sample is only a second or so long as will often be the case. This is further compounded by the fact that a one second sample played an octave up will only last half a second and, an octave up from that, it will only last a quarter of a second. To get round this problem, a sampler uses a process known as looping. This is a technique where part of the sample is played over and over again for as long as you keep your finger on the keyboard. For example, say you have a one second sample of a flute. Using looping, you can instruct the S950 to play the sample through to the end and then, while you keep your finger on the keyboard, it can repeatedly play the last half second of the sample. In this way, you would get the breathy attack of the flute followed by a smooth sustained tone. Well, that's the theory - In practice, it can be more difficult.

You see, many sounds, especially acoustic sounds, can have quite varying amplitude levels and these can be difficult to loop because the loop will be dumping abruptly from one level to another giving rise to unpleasant clicks or 'glitches' as they are called in sampling terminology (see Fig. 1). The length of this loop is set using, not surprisingly, a parameter called LOOP LENGTH.

The art of looping is to find two points in the sample which are of a similar level so that the end of the loop and the start of the loop are matched (see Fig. 2) - this is called a ZERO CROSSING POINT. Sometimes, this can be easy to achieve, sometimes it is impossible. To help you with this sometimes tedious task, the S950 has an AUTOLOOP function where the S950's computer will automatically look for a good zero crossing point and loop the sound for you. Sadly, there is only so much a computer can do in the case of a difficult sound end so the S950 has two looping modes which we looked at above on Page 4 of EDIT SAMPLE. Mode 2 - LOOPING - will loop the sound as described immediately above - i.e. the sound will play from start to finish and then ,lump back to the point in the sound defined by the LOOP LENGTH parameters. Mode 3 - ALTERNATING - will cause the sound to play back to the end and then, instead of ,lumping back to the start of the loop, it will play the loop backwards and then it will play it the right way round then backwards then forwards then backwards, etc., for as long as you keep your finger on the keyboard. This is also known as a BACKWARDS/FORWARDS loop and can certainly help in looping sounds that would otherwise be difficult to loop using ,just the normal looping mode. Figs. 1 and 2 show the difference between the two modes and you can see how the alternating loop has smoothed out the loop portion of the sound. In conjunction with the AUTOLOOP function described above, good loops are often easy to attain. But even this is sometimes not enough to loop certain sounds, especially harmonically rich and varying sounds so the S950 has one further old in the search for the perfect loop called CROSSFADE LOOPING.

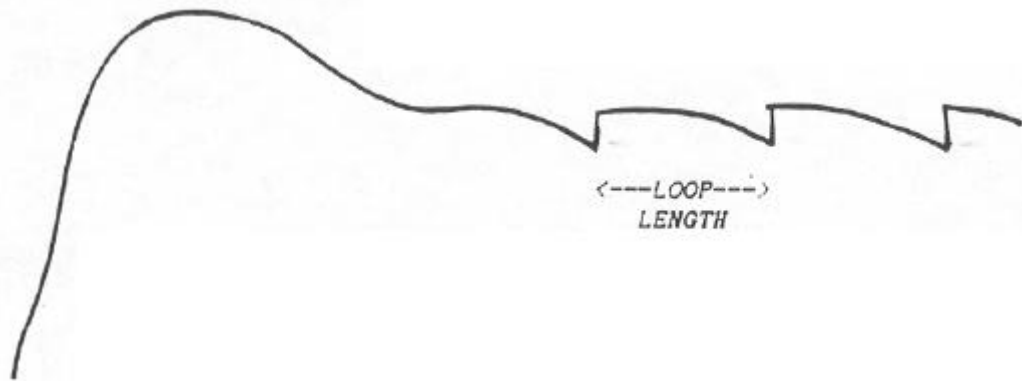

FIG. 1 - Normal looping. Note the abrupt level changes giving rise to 'glitches'

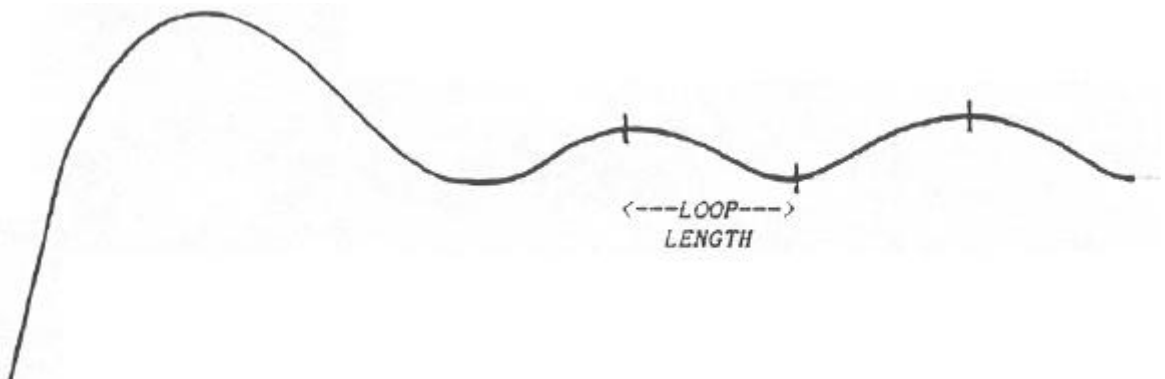

FIG. 2 - Alternating or back wards/ forwards looping of the same sound. Note how the level changes are smoothed out gluing a glitchless loop.

CROSSFADE LOOPING allows you to fade out the glitches that may be present in a loop. Basically, when you employ crossfade looping, the sound plays to the end of the sample and then, instead of the sample jumping back to the start of the loop, the sound begins to fade away as the start of the loop fades in. At the end of the loop, the loop again fades away whilst the start fades in (see Fig. 4) - In this way, the nasty clicks and thumps caused by abrupt amplitude changes at the loop points are faded out enabling a much smoother loop to be created. This mode is certainly the best for attaining a perfect loop end even difficult sounds such as thick strings, brass and vocals, amongst others, can easily be looped and you won't spot the join!

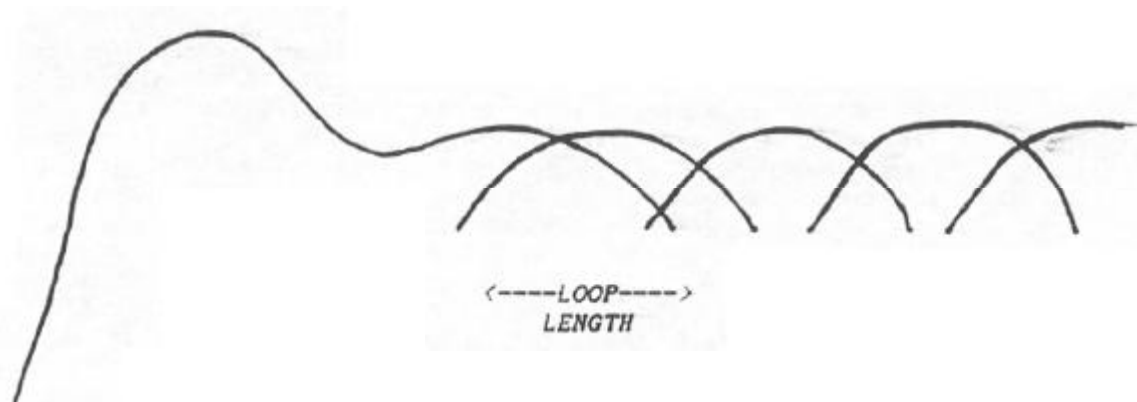

FIG. 3 - Crossfade looping where the start of the loop crossfades with the end of the loop eliminating glitching.

Utilizing all the various looping modes such as AUTOLOOP, ALTERNATING LOOP and CROSSFADE LOOPING, the otherwise arduous task of looping a sound is made a lot easier for you. Having said that, some sounds will still be difficult to loop but this is not a failing of the S950 or yourself but the sound. On occasions, even the wealth of technological assistance that the S950's looping functions offer can encounter sounds that remain stubborn but, as we shall see in the ADVANCED APPLICATIONS GUIDE, there are ways to mask the effect of an awkward loop.

Bearing all this in mind, then, we can now move to the next group of pages which deal with the looping functions on the S950.

Page 08 will display:

```

>08 LOOP LENGTH      #Coarse #Fine  #AUTO
      <# -    #,###)      ^,^^^  (ENT)

```

where '#' is the maximum loop length possible and '^' are the current loop length setting (default on a new sample is 2,000).

Note: To loop a sound, we must first go back to Page 04 of EDIT SAMPLE using the 'page up' button and select either 2 (LOOPING) or 3 (ALTERNATING). You can now return to Page 08 using the 'page down' button.

The various functions in Page 08 are as follows:

'Coarse' allows you to set a rough loop length and 'Fine' allows you to set a finer resolution of loop length. The autoloop function is selected using the ENT button when the cursor is in the AUTO field.

To set a loop, first move the cursor to the Coarse field by pressing the 'cursor >' button once - the cursor will flash on the first number underneath Coarse. You can now set a loop length as long as the figures displayed underneath LOOP LENGTH using either the keypad or the CONTROL knob. To set a finer resolution of loop length, move the cursor one position to the right using the 'cursor >' button and, again using the keypad or CONTROL knob, you can change the data displayed. You might now like to try and play the keyboard to see how it sounds. You should find that the sound will play through to the end and will sustain for as long as you keep your finger on the keyboard but the sustain portion is possibly clicking or thumping or generally glitching. You can now move the cursor to the AUTO field using the 'cursor >' button and by pressing the ENT button, the S950 will search for a better loop. You will note that the loop length you set gets smaller. Try playing the keyboard again and see if the loop has improved. If it hasn't, hit ENT again and the loop length will get smaller as the 950 looks for a better loop. Keep repeating this process until you end up with a satisfactory loop.

Note: It is a good idea to make either a mental or written note of loop lengths that the autoloop may select as the next choice it makes might not be as good as the last and you will be able to return to that loop length later.

It could be, as mentioned. above in 'ABOUT LOOPING', that the autoloop function may not be able to find a smooth loop due to the nature of the sound so it might be wise to try using the ALTERNATING mode instead. If all else fails, you can try using CROSSFADE LOOPING described below.

Let us now move to the next page using the 'page down' button. The display will read:

```
>09 CROSSFADE LOOP.      #Name NEW SAMPLE
X-fade length 32000      #Execute Mem 0%
```

In this page you can execute a crossfade loop.

To do this you must first make a copy of the sample to be crossfade looped so, using the LETTER button, create a new sample name and press ENT. You can now move the cursor to the X-fade length field using the 'cursor >' button. Data can be input using the keypad or the CONTROL knob. Once you have set the crossfade loop length, move the cursor one position right using the 'cursor >' button and hit ENT. There will be a pause while the 5950 calculates the crossfade loop. To hear the fruits of your labours, hit EDIT SAMPLE to take you Page 01 and select the new sample with the crossfade loop. By playing a note on the keyboard or by pressing the PB button, you should find that your loop has been smoothed out considerably. If it hasn't, delete this sample, go back to the original and then repeat the crossfade loop procedure selecting a different loop length.

Note: Because the crossfade loop function requires that you create a new sample, if the S950 already has a memory full of samples, this may not always be possible and the display will tell you that memory space is full. If this occurs, delete some samples (ensuring that they have first been saved to disk, if necessary! so that you make room for the new crossfade loop sample. The field marked MEM on Page 09 will tell you how much memory the S950 has available for the creation of a new sample.

The next page displays:

```
>10 #Resample at half bandwidth (ENT)
      #Discard before start, after end (ENT)
```

This page allows you to make economical use of the S950 memory. The top line allows you to resample the sound at half the original bandwidth and this will free up more memory although the tonal qualities of the sound may suffer. To use this function, simply move the cursor to the ENT field using 'cursor >' and hit ENT - after a short pause, the sample will be available but at half its original bandwidth.

The discard function is similarly executed. Move the cursor to its ENT field using the 'cursor >' button and hit ENT. Anything you have edited out of the sound in Pages 06 and 07 will be erased from memory, thereby freeing up more memory space.

Note: Both of these are destructive functions and there is no way of retrieving the original sample after they have been carried out so it would be wise to save that sample to disk before using this function in case the results are not satisfactory.

The next few pages allow you to merge two samples together to create interesting composite sounds.

Moving to the next page using the 'page down' buttons, the display will read:

```
>11 SPLICE #2nd sample name SAMPLE 2
      X-FADE #New sample name NEW SAMPLE
```

The top line of the display allows you to select which sample in the S950 memory is going to be used as the second sample in the splice whilst the bottom line allows you to name the new sample that will contain both samples - like the crossfade looping function, splice crossfade. requires that you create a new sample so make sure you have enough free memory in the S950.

To select the second sample in the crossfade splice, move the cursor to the SAMPLE 2 field using the 'cursor >' button and scroll through the samples using the CONTROL knob. When you have chosen your second sample, move to the NEW SAMPLE field and name the new sample in the usual way.

You can now move to the next page which displays:

```
>12 #Splice crossfade time, (points)
      (0 - 0> 1000
```

This allows you to set (in sample points) the length of time over which the crossfade will occur. To achieve this, move the cursor one position to the right using the 'cursor >' button and enter a suitable value using the keypad or CONTROL knob. When you have done this, move to the next page which will read:

```
>13 (SPLICE ORDER: 1st then 2nd (1),
      2nd then 1st (2), Together(3) Mem 0%
```

This page allows you to specify which order the samples are to be played in the crossfade. Mode 1 will play the sound currently selected in EDIT SAMPLE followed by the sound selected on Page 11. Mode 2 will play the sample selected on Page 11 followed by the sample currently selected whilst Mode 3 will play them together. To execute this, move the cursor one position right using 'cursor >' and select the required mode, 1, 2 or 3. After a short pause, the spliced sample will have been created and to hear it, hit EDIT SAMPLE and select the new sample on Page 01. If this is not to your liking, erase the new sample and repeat the procedure entering a different crossfade time.

Note: As above in crossfede looping, it is necessary to create a new sample for splicing. If you don't have enough memory, the S950 will not be able to create the new sample so it may be necessary to delete some samples form memory.

Also, when you splice two samples together, the original pitch of the sample is retained. If for example, you splice two samples together, one of which was sampled on C3, the other on G3, the resultant splice will play the samples a fifth apart, even if you retune the NOM PITCH of the second sample on Page 3 of EDIT SAMPLE. If you intend to sample two sounds specifically for splicing, ensure that they ere sampled on the seine note.

The next page is all to do with TIMESTRETCH.

Timestretch is a facility that allows you to either lengthen or shorten a sample without changing that samples pitch over a factor of 999% (<i.e a one second sample can be stretched to a maximum length of nearly 10 seconds). There are many uses for this technique. Firstly, it is possible to change the tempo of a sampled drum loop without changing its pitch. Alternatively, it is possible to change the pitch of the drum loop and then change it back to its original tempo. It can also be used to lengthen samples so that, as you go higher up the keyboard, the sample length remains constant. It is also possible to lengthen or shorten backing vocals which could be 'spun in' in an extended remix. With the EXM006 memory expansion boards fitted it could be used in audio/visual applications to change the overall time of a voice-over without changing pitch - you could even change the playing time of a jingle without changing pitch. Similarly, you could transpose the pitch of the jingle and then revert to its original tempo.

Move to Page 14 using the 'page down' button and the display will read:

```
>14 STRETCH #New name NEW SAMPLE #200%  
D-time 1000 #Auto D_ 4Monl/Pol2 2 #Do_
```

As with crossfade looping and splice crossfade, it is necessary to create a new sample so move the cursor one position to the right by pressing the 'cursor >' button and enter a new name in the usual way and hit the ENT button. Now move the cursor one more position right and select the 'percentage by which you want to stretch or compress a sample.

Note: as you have to create a new, longer sample it is quite feasible that you may not have enough memory. Ensure, then, that if you are stretching a sample, particularly a long one, that you have enough free memory to accommodate it. If you do not have enough memory, the display will tell you.

The next field allows you to set what is known as a D-TIME. When you stretch a sample, you are basically instructing the S950's computer to play the sample and, in order to lengthen it, to fill it in with bits of information thereby making it longer. Compressing a sample removes certain bits of information so making it shorter. With extreme timestretch values, the end result can sometimes sound slightly metallic. The D-TIME function smooths things out allowing you to suppress this effect. Longer, D-TIME values will give the sample a slight tremolo effect whilst shorter D-TIME values give rise to the metallic effect. Select a D-TIME value as you think appropriate. Of course, this only happens on extreme stretch or compression percentages. To further assist you in selecting a suitable D-TIME, there is an AUTO-D function which, like autoloop, gets the S950 to select a suitable D-TIME value.

The next field, Monl/Pol2, allows you to select whether the sample you are stretching or compressing is a monophonic or polyphonic sample. The 'Monl' setting is more suitable for lengthening a single tone whilst the 'Pol2' is better suited to lengthening polyphonic samples such as backing vocals, drum loops, etc.. It is best just to experiment with the various options until you arrive at the best sounding result.

To change the data in any of these fields, move the cursor to the appropriate position and change the value displayed using the numeric keypad. When you have done this, move the cursor to the 'DO' field and press ENT and the S950 will pause for a short while whilst it calculates the new sample (the EDIT SAMPLE light will remain lit). When this is done (i.e. when the EDIT SAMPLE light begins to flash again), hit EDIT SAMPLE and select the new sample on Page 01. Play a note on the keyboard or hit the PB button to hear the results. If you are not happy with the new sample, delete it and select the original sample to repeat the procedure.

Note 1: Timestretch will require some experimentation. It is not unlike looping in this respect and you may need several tries at it before you get a timestretch sample sounding just right. Bear in mind what is going on here in this process and realize that you can only expect a sample to be stretched or compressed a certain amount before some degree of irregularity in the samples' tone becomes apparent.

Note 2: The looping for the stretched/compressed sample will remain the same as the original samples. As a result, if the original sample was looped, you will have to edit the new timestretched sample and change its loop length to something more suitable.

That concludes our examination of EDIT SAMPLE. As always, the default settings in this mode have been well chosen and it is probable that, in the majority of sample editing situations, you will only need to edit start time, end time and looping with the rest of the functions being used for special applications. Having now seen how to sample a sound and edit it, we can now move on to EDIT PROGRAM where we can further refine the sample (s) we have taken.

EDIT PROGRAM

Once you have your sample(s) in the S950, you will want to organize them so that they are properly laid out across the keyboard. All this and more is done in the EDIT PROGRAM mode using KEYGROUPS. We have already had a brief look at what a keygroup is in the S950 BASIC ARCHITECTURE section of this manual but before we go on to see what EDIT PROGRAM has in store for us, let us first find out what a keygroup actually is.

A keygroup is something into which you place a sample within a program. The keygroup can be given a highest and lowest note assignment and so can be spread out across the keyboard in any number of configurations. The simplest program you could have would be to have one sample in one keygroup spread out across the entire range of the keyboard. A more advanced program would be to have keygroups assigned to individual notes or groups of notes with a separate sample in each one so that each note or group of notes on the keyboard has a different sample on it. This particular application, known as MULTI-SAMPLING, is useful in sampling certain instruments such as vocal sounds, piano, guitar, etc., that require a series of different samples across the keyboard range because the tonal quality of these sounds changes when a sample is transposed too far from the original pitch. This technique is also useful for creating drum programs where every drum can be assigned to a different note on the keyboard.

Using the keygroups, it is also possible to create split keyboard effects where you could have, for example, bass guitar on the bottom two octaves and piano on the top three octaves. It is also possible to layer two keygroups on top of each other for layering and chorus effects. Furthermore, a keygroup can have two totally separate samples within it each of which can be sounded depending on how hard you hit the keyboard this is known as VELOCITY SWITCHING where attack velocity switches in one of the two samples depending on the force with which the keyboard is hit. The prime application of this is to take a soft sample of a sound and a hard sample of a sound to reproduce the tonal differences in their dynamic range. For example, you may take a sample of a softly plucked bass guitar and a slapped bass guitar and you could switch between them using keyboard dynamics. Alternatively, for special dynamic effects, the two samples switched using keyboard velocity could be distorted guitar and feedback or damped and open 'picked guitar or they could be two different slightly different drum sounds for more authenticity when creating drum programs. They could even be totally different sounds such as strings and brass - the possibilities are endless)

As if all this weren't enough, a keygroup allows you to modify the sample itself and it is possible to affect loudness, adjust the tone with a filter and tune the sample as well as add amplitude and filter envelope shaping, vibrato and pitch sweep. You can also assign individual keygroups (and hence the samples within them) to separate MIDI channels and audio outputs for multi-timbral sequencing. EDIT PROGRAM, therefore, is the key to getting the raw samples sounding great. And remember, because all the parameters in EDIT PROGRAM are simply processing variations, those raw samples are not affected and so you can create any number of variations on one sample without using any valuable memory.

Having understood that, let us now see what facilities we have to play with in EDIT PROGRAM.

When you hit the EDIT PROGRAM button, the first page displayed reads:

```
>01      #Select, Copy      #####  
PROGRAM  #Rename, Delete(-) #####
```

where ##### 1 s the program name.

As in EDIT SAMPLE, this allows you to select a program for editing and to copy, rename and delete a program. if you wish to select a program, move the cursor one position to the right using the 'cursor >' button so that the cursor is flashing on the first letter of the program name. You can now scroll through the programs in the S950 using the CONTROL knob and hitting ENT when you have found the program you want. To copy a program you simply type in the new program name using the LETTER button and hit ENT when that is complete.

To rename a program, you move the cursor to the bottom line using the 'cursor >' button and, using the LETTER button, give the program a new name, hitting ENT when that is done. To delete a program, use the - button and ENT to delete the selected program. For more detailed information, refer to Page 01 of EDIT SAMPLE which is exactly the same.

Note: There is no 'program Initialize' function. To create a brand new program from scratch, you must either copy or rename another program (the TONE PROGRAM, for example) and use that as the basis of your new program.

When you have finished in this page, you can move to the next which will display:

```
>02 #MIDI prog 1 #Key-loudness +00  
      #Positional crossfade OFF
```

In this page you do a number of things. Firstly, you can set the program number that this program will respond to over MIDI. For example, the currently selected program may be program number 4 in the 5950 but you want to use it with program number 35 on your controlling synth or keyboard. To do this, simply move the cursor to the MIDI prog field and change the number 1 to 35 using the CONTROL knob or keypad. Whenever you call up program 35 on your MIDI controller, this program will be recalled. Each program in the S950 can be assigned its own MIDI program number for recall using the MIDI controller.

Key-loudness refers to the volume of the sound over the keyboard range. For example, you may have a sound that is too loud down in the bottom octaves and drowns out the notes in the top registers - moving the cursor to the key-loudness field using the 'cursor >' button, you can set a value using the CONTROL knob or the keypad that will compensate for this. A value of +00 will have no effect on the level of the sample across the keyboard range whilst a value of -50 will reduce the level in the upper octaves and increase the level in the lower octaves. Conversely, a value of +50 will increase the level of the upper octaves and decrease the level in the lower octaves.

Positional crossfade is a facility whereby you can overlap two keygroups and, with positional crossfade set to ON, as you go from one keygroup to the other, they crossfade with the one keygroup fading out and the other keygroup fading in. This can be especially useful when using multi-samples of one instrument because sometimes the change in tone from keygroup to another can seem abrupt. Positional crossfade will smooth these transitions

out resulting in a more consistent tonal change between keygroups. To switch positional crossfade on, move the cursor to where it says OFF and press the ON button.

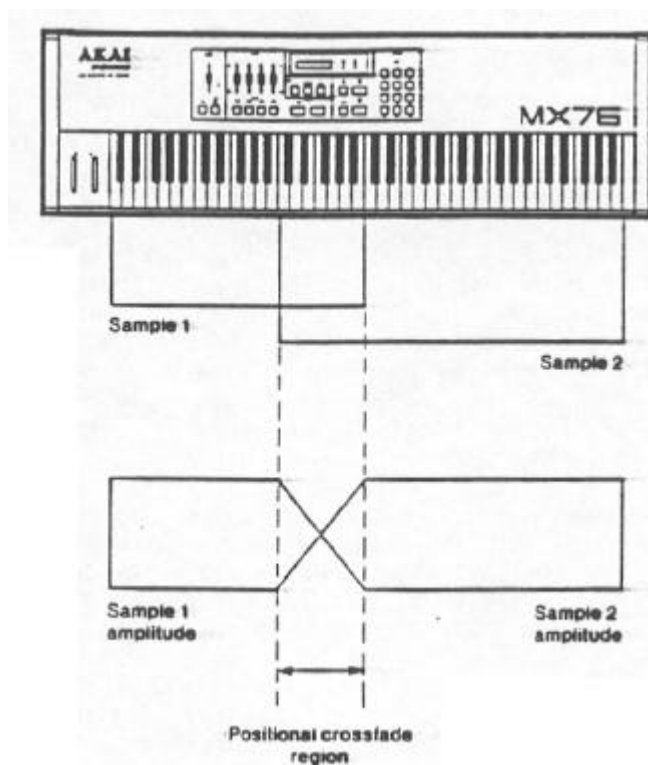

Fig. 1 - Positional crossfade

You can now move to the next page using the 'page down' button. This will display:

```
>03 KEYGROUP: #Select ( 0 to #) ^
          #Put- #Get_ #Copy (+), Delete <->
```

where # is the number of keygroups in the selected program and t is the currently selected keygroup.

This page allows you to select a keygroup to edit as well as copy and delete individual keygroups. It is also possible to insert a keygroup from another program into the currently selected program using the GET function and you can also place a keygroup from the currently selected program into another program using the PUT function.

To select a keygroup, simply move the cursor to 'Select' by pressing the 'cursor >' button and if there is more than one keygroup in the program, you can scroll through them using the CONTROL knob or you can select keygroups with the keypad. You will note that it is possible for you to edit all keygroups simultaneously when the display reads 'ALL' - this makes 'global' editing of the program easier. For example, you may want to change the attack time of all the keygroups - Instead of laboriously editing each one separately, you can edit them en masse using the ALL selection.

To copy a keygroup, simply move the cursor to 'Copy (+>, Delete <->' using the 'cursor)' button and press the ON(+) button - this will copy the currently selected program (*note: if your selection is ALL, this function will not copy all the keygroups*). To delete a keygroup, simply press the OFF(-> button and this will delete the selected keygroup.

The PUT/GET function available on this page is invaluable in making or editing programs that have similar parameters to other programs. For example, you may be creating or editing a drum program and you want to 'grab' the snare drum from another program complete with the envelope shaping, tuning, volume and other keygroup parameters from another drum program currently in the S950.

To achieve this, follow this procedure:

Select the source program (i.e. the program where you want to take the keygroup from) and go to Page 03 and move the cursor to the 'Select' field to select the keygroup you want to copy to the other program. When you have done that, move the cursor to the PUT field and press ENT. Now go back to Page 01 by pressing EDIT PROGRAM and select the program in which you wish to place that keygroup in (i.e. the one you were editing/creating). Go to Page 03 and move the cursor to the GET field and press ENT. You have now copied a keygroup from one program to another.

IMPORTANT NOTE FOR PAGES 04 to 16

The display shows the currently selected keygroup number underneath each page number. To change keygroups at any time, instead of constantly returning to Page 03, you can move the cursor one position to the right and select a new keygroup using either the CONTROL wheel or the keypad. This will speed up your program editing enormously as well as allowing you to compare different keygroups parameters with the minimum of button pressing.

The next page, Page 04, allows you to adjust the velocity threshold for velocity switching and will look like this:

```
>04
      #KG#    #Velocity switch threshold 128
```

where # is the currently selected keygroup.

As you play the MIDI keyboard, it produces a stream of numbers that corresponds to your playing dynamics. These numbers can be anywhere between 0 and 128 with 0 representing a soft keystrike and 128 representing a hard keystrike. With the velocity switch function, you may select a value below which only a soft sample will play and above which only the hard sample will play. This is normally used to more accurately reproduce the sampled sounds dynamic range but it can be used for other effects as well such as the muted/picked guitar effect described earlier. Of course, there is nothing to stop you switching between two totally different samples such as strings and brass, for example.

To change the data, first select the keygroup you wish to edit by moving the cursor one position to the right and then move the cursor to the data field using the 'cursor >' button and input a value using the CONTROL wheel or the keypad.

Note: A setting of 128 will only play the soft sample since it is not possible to play a hard sample with a velocity value of more than 128. Similarly, a velocity switch threshold of 000 will only play the hard sample as it is not possible to play a soft sample softer than 000.

Now move to Page 05 which will display something like:

```
>05 fSoft sample TONE          at C3 60
      *KG#      Low key C0 24 #Hi key GS 127
```

where # is the currently selected keygroup.

This is a very important page as it is here that you map your keygroups (and hence individual samples) across the keyboard range and it is possible to assign a keyboard range of as much as seven octaves or as little as one note.

To assign a sample to a keygroup, first select the appropriate keygroup by moving the cursor one position to the right using the 'cursor >' button and make your selection using either the CONTROL knob or the keypad. Now move the cursor one more position to the right and use the CONTROL knob to scroll through the samples in memory. When you have found the required sample, press ENT and this will place the chosen sample in that keygroup. To assign the samples lowest note, move the cursor to 'Low key' and use either the CONTROL knob or a three digit number on the keypad to set the lowest note. To adjust the highest note for the sample, move the cursor to 'Hi key' and enter your note value using the CONTROL knob or a three digit number on the keypad.

You will notice that for every sample you select in any keygroup, this page will also show you that samples base note or nominal pitch (i.e. the key it was sampled onto) in the top right hand corner of the display. This is very useful in setting up a program that uses extensive multisampling.

(Note: If you have set a velocity switch threshold of 000 on Page 04, this page will display "No soft sample, vlcty thrsh = 0")

Having placed your sample and assigned its upper and lowest note ranges, you can now move to the next page which will display:

```
>06 S Loudness iFilter *Transpose *Fine
      #KG#      +00      99      +00      +00
```

where # is the currently selected keygroup.

This page allows you to effect the loudness, tone and tuning of the soft sample. To do this, simply select the appropriate keygroup by moving the cursor to the KG field and then move the cursor to the Loudness field and make your data entry using the CONTROL knob or the keypad in conjunction with the + or - buttons. You can then move the cursor one position to the right to affect the filter settings (and hence the samples tone) and you can tune the sample up or down 50 semitones using the Transpose field and you can fine tune the sample using the Fine field.

This page is very important in a mufti-sample program as you can balance the respective levels of every sample, adjust the tone so that timbre is uniform from one keygroup to another and you can transpose and fine tune individual keygroups using the transpose and fine tune parameters. Of course, if you wish to affect all keygroups simultaneously with any of these parameters, select ALL in the KG field and edit the data as you wish.

In this way, you could, for example, transpose the whole program up an octave or any other interval or you could fine tune the program so that it is in tune with other programs in memory. You could also turn the whole program up or down in level to balance the program against other programs.

Note: The loudness parameter is a MIDI velocity based parameter. If it is set to +50, keyboard velocity dynamics will have no effect on the keygroups loudness. If this is a problem when you wish to make a particular keygroup louder, it is suggested that you turn the other keygroups loudness down.

The next two pages, 07 and 08, are concerned with the hard sample if velocity switching is used. These two pages are identical in their function so please refer to the information given about Pages 05 and 06 above.

Page 09 is used to adjust the filters ADSR settings and the display reads:

```
>09 VCF #Attk tDcay tSstain fRlse tAmnt
      tKG#      20      20      20      20      +00
```

where # is the current keygroup selection.

The filter in Pages 06 and 08 can be controlled by this envelope generator which allows control over attack, decay and release time and also sustain level. The amount of effect this ADSR generator has on the filter is governed by the AMOUNT (Amnt) parameter which can have a positive or negative going effect on the filter. This envelope generator has a number of uses. Firstly, It is possible to treat the 5950 like a conventional analogue synthesizer adding filter sweep effects to any samples. Alternatively, it can be used to 'shape out' any noise that may be present at the end of a decaying sample.

To adjust the parameters, first select the appropriate keygroup in the usual way and then move the cursor across the screen using the 'cursor >' or left buttons making your data entry using the CONTROL wheel or the keypad.

Note: The effect that these controls have on the filter is very dependent on the filter settings in Pages 06 and 08. With the filter settings at 90 or more, the envelope will be unable to sweep through the filters cutoff frequency because it is already at maximum. Hence, the filter value on pages 06 and 08 will have to be reduced to have any effect. Having said that, this only applies to positive values entered in the 'Amnt' field on Page 09 (i. e. +01 or more). If you want an inverted filter sweep (i. e. an 'Amnt' value of -01 or more), you will have to set the filter parameters in Pages 06 and 08 fairly high. Here are some rules of thumb about filter sweeps.

1: For a wide positive going sweep, set the FILTER parameters low and the AMOUNT parameters high (i.e. +50).

2: For a mild positive going filter sweep, set the FILTER parameters between medium and three quarters and set a medium level of AMOUNT.

3: For a wide negative going filter sweep, set the FILTER parameters high and the AMOUNT parameter to a high negative value (i.e. -50).

4: For a mild negative going sweep, set the FILTER parameters three quarters to high and a medium level on negative going AMOUNT (i. e. -25)

Variations on those should be experimented with for a wide range of filter effects.

Let us now move to Page 10, the amplitude envelope settings. This page looks like this:

```
>10 ENV ;Attack *Decay *Sustain (Release
#KG*      0      80      90      30
```

where # is the current keygroup selected.

This page is similar to Page 09 except that this envelope generator affects the overall amplitude of the keygroup. As well as restoring the natural envelope of a looped sound, this page is useful for adding new and interesting envelope shapes to samples and such things as 'bowed piano' are possible where a piano sample is given a slow attack. This page is also useful for fading out noise at the end of a sample.

As above, data entry is made by selecting the required keygroup in the KG field and moving the cursor across the display in the usual way with the 'cursor >' or left buttons.

ABOUT ENVELOPE GENERATORS

The envelope generator is an extremely important item when synthesizing or sampling a sound as they allow you to modify the way in which the sound is presented to us. For example, a drum sound starts instantly and dies away very quickly and this is true of most percussive sounds. A violin, however, starts slowly, sustains for as long as the player bows and then dies away quickly whilst a piano starts quickly and dies away over a long period of time, sometimes many seconds. This method of presentation is known as the envelope and all synths and most samplers allow quite intricate control over a sound's envelope. Of course, the beauty of synths and samplers is that it is possible to apply the envelope of one instrument on another so that we end up with the bowed piano example given above or we could have a super percussive guitar.

An envelope can be broken down into four main portions:

ATTACK - This is the time it takes for the sound to reach its full volume.

DECAY - This is the time it takes for the sound to die away to its sustain level.

SUSTAIN - This is the level at which the instrument will sustain during held notes.

RELEASE - This is the time it takes for the sound to die away after the note has finished.

By controlling these parameters, it is possible to recreate the envelopes of a wide range of acoustic instruments as well as create some unusual synthesised effects.

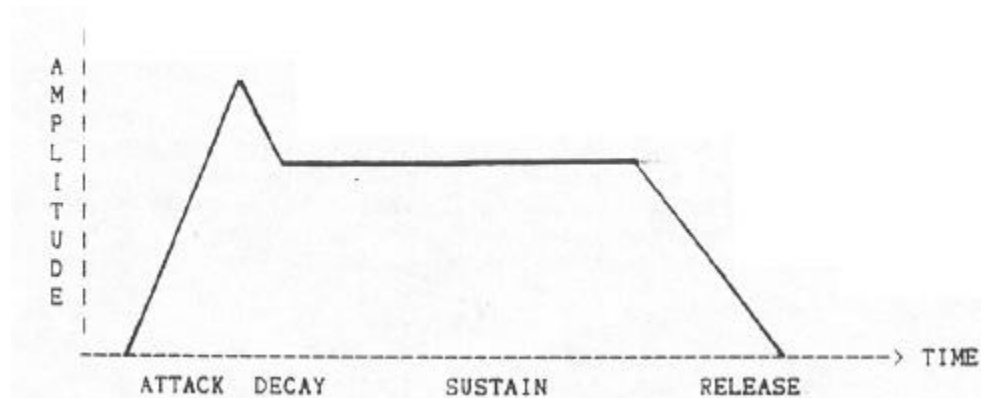

Furthermore, most, if not all acoustic instruments exhibit tonal envelope changes where the tone varies during the course of a note. By providing a separate envelope generator for the filter, we are also able to imitate these effects as well as set up some interesting, electronic effects.

The next page is concerned with the velocity parameters of a keygroup ° 1, e how keyboard dynamics will affect the sound. The display reads:

```
>il VLCTY Loudness 30 (Attack 0
#KG# SENS Filter 10 #OFF* Release +00
```

where # is the current keygroup selection.

The parameters function as follows:

LOUDNESS: This allows you set the amount with which velocity will affect a keygroups volume. With a setting of 00, velocity will have no effect whilst a setting of 99 will make that keygroup extremely sensitive to velocity. Default is 30 and gives an average range of velocity extremes.

FILTER: This allows you to modify tone using keyboard velocity. It is common on most acoustic instruments that their tone will be brighter if played harder. Similarly, tone is usually softer if the sound is played quietly. Using this parameter, you can duplicate this effect using keyboard velocity. As above, 00 represents no effect and 99 represents the most sensitive.

(Note: If the FILTER setting !n Pages 06 and 08 are set to 99, this parameter will have no effect, however high you set it. To hear the effect, reduce the FILTER setting in Pages 06 and 08).

ATTACK: This allows you to control the envelope generators attack time using velocity. This can be especially useful on woodwind and string sounds where attack time varies with dynamics. With a setting of 0, no effect will **be heard** whilst a setting of 99 will have the most effect.

(Note., If attach times are set to 00 on pages 09 end 10, this parameter will have no effect. To hear velocity control of attack time, set the envelope generators attack times to around 20 et least).

RELEASE: This allows you to control release time using keyboard velocity. A setting of +00 will have no effect whilst settings of +50 will give the effect that releasing the keys quickly will give long release times. Values of down to -50 will have the reverse effect and release time will be shorter when you take your fingers off the keyboard quickly. (**Note: Release times on both envelope generators have to be set to at least 50 to hear this effect**)

OFF: Not all keyboards have release velocity so this function allows you to use attack velocity to control release times. Selection is made using the ON(+> or OFF(-> buttons.

All data entry is made in the usual way. First, select the keygroup you want to edit using the KG field and then move the cursor across the screen using the 'cursor > and/or <' buttons. Data can be input using the CONTROL knob or the keypad. The default settings have been sensibly chosen on this page and it is often unnecessary to have to change any of them. As a result, you can go to the next page which displays:

```
>12  WARP *Velocity 0          Time 99
      #KG#      *Attack offset +00
```

This allows you to add a pitch sweep to a note's attack so that the sound starter slightly sharp or flat depending on the settings of this page. This can be used to create more realistic brass, sax and vocal and choir effects as well as a whole variety of special effects. It can also be used to add pitch bend to drums to add some 'zest' to a badly tuned kit.

Data is input in the usual way by selecting the required keygroup and moving the cursor across the display using the 'cursor > and/or <' -buttons and entering numeric values using the CONTROL knob or the keypad. The various fields offer the following facilities.

VELOCITY: This field allows you to vary the effect of pitch warp using keyboard attack velocity. 0 = no effect. Of course, this parameter will have no effect regardless of its settings if the ATTACK OFFSET field described below is set to 00.

TIME: This sets the length of time the pitch bend takes. 0 = short with pitch bend times getting longer with higher settings.

ATTACK OFFSET: This sets the amount of pitch sweep. Negative going values (i.e. -50> give an upwards rising pitch sweep whereby the pitch slides up to the note and positive going effects (i.e. +50> have the opposite effect with the pitch sliding down to the note.

The next page is also concerned with pitch sweep effects and is where you can set the parameters for the Low Frequency oscillator or LFO. The page reads:

```
>13  LFO  (Depth #Rate *Delay +Desync
      fKG#      0      42      64      ON
```

where # is the currently selected keygroup.

As usual, data can be input by selecting the appropriate keygroup and moving the cursor to the required fields using the 'cursor < and/or >' buttons and then setting parameters using the CONTROL wheel or the keypad. The functions are fairly self-explanatory and are:

DEPTH: This sets the amount of LFO sweep. 0 = no effect with modulation depth increasing with higher numeric values. With any value higher than 1, the LFO effect will be a permanent part of the sound.

RATE: This sets the speed of the LFO pitch sweep. 0 = very slow and the LFO rate gets faster as you increase the settings (note: the ranges of 30-45 are recommended for typical vibrato effects).

DELAY: ,This sets the time it takes for the LFO to fade in with its effect. This is particularly useful for natural vibrato effects if you are not able to use the modulation wheel.

DESYNC: There are no less than 8 LFO's in the S950, one for each voice. When DESYNC is ON, these LFO's run slightly out of phase with each other allowing you to create more natural ensemble vibrato effects. With DESYNC OFF, the LFO's are phase locked and so produce LFO effects more like those found on synthesizers that normally only have one LFO to affect all voices. DESYNC is switched on or off using the ON and OFF buttons.

The next page, Page 14, is also to do with the LFO and looks like this:

```
>14 LFO DEPTH #Aftertouch *Mod wheel
      IKG#                0          50
```

where # is the current keygroup selection.

This page allows you to add vibrato and other LFO effects over and above those set in the DEPTH field on Page 13 using aftertouch (if your keyboard generates it, of course) and/or the modulation wheel. The display shown is the default and so will not require much, if any editing. As you would assume, higher values on either of these parameters increases the amount of effect either aftertouch or the mod wheel will have on the introduction of LFO effects.

The next page allows you to control tone over the keyboard range as well as turn the keyboard off and looks like this:

```
>15  *Key-filter ;Const pitch *One-shot
      *KG#        50          OFF      OFF
```

where, once again, # is the current keygroup selection.

KEY-FILTER is similar to the 'keyboard track' control available on every analogue synthesizer and this allows you to vary the tonal balance across the keyboard. This can be useful when using certain samples that 'screech' in the upper reaches of their range or samples that are noisy when played a few octaves down. By setting a higher key-filter setting, the sound will get mellower further up the keyboard. A setting of 00 has no effect on the sound. The default is 50 and can usually be left.

The CONST PITCH field allows you to effectively turn the keyboard off so that it will have no effect on the pitch of the sample. This can be useful in a number of ways. For example, with a drum program, it is often desirable to place certain drums over a small range of notes in order to play rolls and fill more easily. Unfortunately, if you do this, the pitch of the drum changes so by switching CONST PITCH to ON, the pitch of these drums will remain constant regardless of what note you play.

The ONE-SHOT function caters for use of the 5950 with certain drum machines whose note on message is so fast, it cannot trigger samples in the 5950 properly. If you have such a drum machine and don't get a sound even though everything seems to be working o. k., switch this to ON as this may cure the problem. If it doesn't, you may have some other problem.

The next page allows you to set the MIDI channel for individual keygroups and the display reads:

```
>16      *MIDI Channel   This keygroup on
          *KG# offset0-15>      MIDI ch. ALL
```

The 5950 has a very flexible MIDI Implementation. Any keygroup can be assigned to any of the 16 MIDI channels and this allows you to set up a program for multi-timbral operation where each sound plays a different part on a different MIDI channel.

This page operates as follows:

It is possible to 'offset' a keygroups MIDI channel against the 5950's overall MIDI channel as set in the main MIDI pages. Say, for example, the 5950 is set to a global MIDI channel of 1 with OMNI OFF, in this page of EDIT PROGRAM, you could offset a keygroup by a factor of 3 so that it would respond to any incoming messages on MIDI channel 4 (i.e. base channel+3=4). Similarly, if the 5950's global channel was set to 5 with OMNI OFF, an offset of 7 would place that keygroup on MIDI channel 12. In this way, any keygroup can be addressed on any MIDI channel. A typical example would be where you wish to run a few instruments on separate MIDI channels for multi-part sequencing.

You may have drums in keygroups 1 to 5, a bass sound in keygroups 6 to 8, an electric piano sound in keygroups 9 to 12 and a simple synth brass sample in keygroup 13. The only way to run these sounds from a sequence without the MIDI OFFSET function would be to map them out so that the keygroups do not overlap each other in their lowest and highest note assignments. This is actually a perfectly valid way of doing this except that you would only have limited note ranges for each instrument.

Better would be to map these instruments out as they should over the entire keyboard range if you were to play them with MIDI OMNI ON, all those samples would sound together. By pressing the main MIDI mode and switching OMNI to OFF and selecting MIDI channel 1, you can now go back into EDIT PROGRAM, go to Page 16 and give these keygroups their own MIDI channel. For instance, as you want the drums on MIDI Channel 1, you needn't offset keygroups 1-5, the bass keygroups you can offset by a factor of 1 which will place them on MIDI channel 2, the piano keygroups can go on channel 3 so offset those keygroups by a factor of 2 and the synth brass can be offset by 3 so that it responds to MIDI channel 4.

If that sounds complicated, it isn't and here's how you achieve that.

Move the cursor to the KG field using the 'cursor >' button and select the appropriate keygroup. Press 'cursor >' again so that the cursor is on the 'MIDI ch' field and change the data using the CONTROL knob or the keypad. Press the 'cursor <' button and change the keygroup and press 'cursor >' again to change that keygroups MIDI channel offset value. Repeat this process for all the keygroups in the program.

Using this page, it is possible to set up whole multi-timbral configurations and these can be saved to disk for instant retrieval. You can also have the individual Instruments within this program available as separate programs for normal playing on the same disk giving you extra flexibility.

Note: If OMNI is switched to ON In the main MIDI mode. the MIDI ch field on this page will show 'ALL' For multl-tlmbral sequencing as described above, OMI must be switched to OFF In the MIDI mode.

Of course, for normal playing of programs. It could be that you don't need to change a programs MIDI channel so Page 16 can be often ignored and the programs overall MIDI channel can be set in the main MIDI mode.

(For further information on setting the 5950's main MIDI channel and for setting OMNI refer to the section on the MIDI mode.)

The last page in EDIT PROGRAM is concerned with assigning individual keygroups to separate outputs. The display shows:

```
>17      (OUTPUT  All(00), Mono (01-08)
          IKG# VOICES) Left(09), Right(10) 0
```

where * is the currently selected keygroup.

To assign a keygroup to an output, move the cursor one position to the right using the 'cursor >' button so that it is on the KG field and select the required keygroup. Press 'cursor >' again so that it is on the output assign field and make your data entry using the CONTROL knob or the keypad. This will assign that keygroup to the chosen output.

As in nearly all the various modes in the S950, **there are many** default settings which have been sensibly chosen to optimise the units performance. Because of this, it is often possible to create a program from scratch ignoring many of the pages thereby making program editing and creation far quicker and easier. With more familiarity with the unit, you will soon discover the versatility of the S950 and how important EDIT PROGRAM is in the creation of good sounds.

That concludes our look at EDIT PROGRAM. As you can see, there are a lot of advanced features contained within it that allow you to get the best out of your samples. We will look at other uses for EDIT PROGRAM in the ADVANCED APPLICATIONS GUIDE which will show you how to~layer sounds, create split keyboard programs, use the LFO and WARP functions and how to use the individual outputs to the full.

MIDI FUNCTIONS

Next to the EDIT PROGRAM button is the MIDI button and here you can set the basic 'global' MIDI parameters for the 5950.

To access the MIDI pages, press the MIDI button and the display will read:

```
>01 *Basic MIDI channel      *Omni on/off
      (01 to 16) 1           ON
```

These are the default settings if you turn the S950 on with no disk inserted. It tells you that OMNI is switched to ON (i.e. it will receive all MIDI channels and so will operate with the MIDI controller regardless of its setting). To set the S950 so that it responds to one channel only, you must turn OMNI to OFF and this is done by moving the cursor to the Omni on/off field by pressing the 'cursor >' button twice and then pressing the OFF(-) button on the blue keypad. You can now move the cursor to the Basic MIDI channel field by pressing the 'cursor <' button and make your data entry using the CONTROL knob or by inputting a two digit number on the keypad. The 5950 will now only receive MIDI on the selected channel only.

Note: The channel selected here sets the base MIDI channel for the 5950. Using Page 16 In ED17 PROGRAM. you can. of course, set individual keygroups to respond to different MIDI channels relative to this base channel using the MIDI channel offset feature in order to set up a multi-timbral situation suitable for multi channel sequencing. Please refer to ED17 PROGRAM for more information on this.

The next page displays:

```
>02 MIDI      #Channel  (Key  (Velocity
      TEST      1        C3 60    64
```

which is the default setting.

It is possible on the 5950 to sample, edit a sample and create or edit a program without the need for an external MIDI controller by using the PB or '**playback**' button located near the blue keypad. In any of these modes, you can hear the sound you are working on simply by hitting the PB button. This page allows you to set the channel, note and velocity of the PB button's functions. Furthermore, when you hit the PB button, the note parameters specified in this page are sent through the S950's MIDI output to simultaneously trigger an external MIDI synth, sampler, drum machine or module.

To alter the default settings, simply move the cursor to the appropriate field using the 'cursor >' and/or '<' buttons and make the data entry using the CONTROL knob or a two digit number on the blue keypad.

Page 03, the next page, is extremely useful for checking incoming MIDI data to the 5950. The display reads:

```
>03 RECEIVE Channel      Key      Velocity
      MONITOR    ##      ## ##      ##
```

where # is the incoming data.

Basically, this page 'reads' all incoming MIDI data and then displays it instantly on the screen. To see this in action, simply play a note on your MIDI controller and see what happens. The 'Channel' field will display the

controllers **MIDI** channel, the 'Key' field will display the note played and the 'Velocity' field will display the velocity value with which the key was struck.

The uses of this page are many. You can use it to troubleshoot, checking that the 5950 is actually receiving **MIDI**, what notes and velocity the **MIDI** controller is sending and whether it corresponds to the **MIDI** channel settings of the 5950.

This page can also be useful if you have a drum program in the 5950 and you are using the 5950 with a **MIDI** drum machine or pads as you can determine what **MIDI** notes are being sent by which drum pad thereby allowing you to match your keygroups' note assignments in **EDIT PROGRAM** to the controllers drum pads.

As this is solely a **MIDI** monitor, there are no parameters that you can change.

Note: the display shows the *LAST* piece of *MIDI* Information received. If chords are played into the 5950, it will display the last note received. Similarly, if you are sequencing the 5950 on many *different MIDI* channels, it will also display the last note received along with that notes' *MIDI channel*.

Page 04 allows you to set the S950's response to program change over **MIDI**, whether **MIDI** volume controller (07) is selected and pitch bend range. The display reads:

```
>04 MIDI: tProg change ON *loudness OFF  
          tPitch wheel range (+/- semitones) 7
```

which is the default setting if the 5950 is powered up with no disk inserted.

To change any of these settings, move the cursor to the appropriate field using the 'cursor > and /or <' button and make your data entry using the ON/OFF buttons, the CONTROL knob and/or the blue keypad.

For example, to select that the S950 will not respond to program change over **MIDI**, move the cursor to the 'Prog change' field and press the OFF(-) button. This will disable program change and changing programs on the **MIDI** controller will have no effect on the 5950. To select whether the 5950 responds to **MIDI** controller 7 (volume), move the cursor to the 'loudness' field and select either on or off using the ON(+) or OFF(-) buttons accordingly. With loudness switched to ON, the S950's output level can be remotely controlled from any **MIDI** controller that transmits **MIDI** control 7. This can be useful if the S950 is out of the way in a rack (i. e. on stage in particular) and you wish to turn its volume up or down remotely from the **MIDI** controller. It can also be useful if you are sequencing the 5950 multi-timbrally as you can use the sequencer to mix the various parts on the 5950.

Finally on this page, you can set the range over which the pitch bend wheel is to have effect. The default setting is 7 semitones and this can be changed by moving the cursor to the 'Pitch wheel range' field and making data entry using the CONTROL knob or by entering a two digit number on the **blue keypad**.

Note: the pitch *bend range* is common to all programs and samples contained *within the S950's memory*.

The next page is concerned with the 5950's ability to be controlled using the RS232 multipin port found on the rear of the unit. This allows the S950 to be controlled by computer for sample editing, etc., instead of **MIDI**.

The display for this page reads:

```
)05 Control by MIDI (1) RS232 (2> 1
tRS232 Baud rate 9600 ACTUAL: 9615
```

This is the default setting and the display shows that the 5950 is set for **MIDI** operation. To control the 5950 using the RS232 port, you must move the cursor one position to the right using the 'cursor >' button and select '2' using the CONTROL knob or the keypad. It is necessary to match the 5950's RS232 baud rate to the computers and this is done by moving the cursor to the 'RS232 Baud rate' field and inputting data using the CONTROL knob or the blue keypad. The 'ACTUAL' field displays the incoming signal's baud rate. If it is more than +/-2x different from the intended Baud rate, you may have problems.

For further information on the RS232 protocol used on the 5950, please refer to your local Akai dealer or to your country's distributor who will supply you with the relevant documentation.

That concludes our examination of the **MIDI** pages. Once again, as in all modes of operation in the S950, the default settings of these pages have been sensibly chosen and it is quite likely that you will not have to change them and probably the only MIDI function you will need to change is the MIDI Channel receive number and the OMNI ON/OFF selection on Page 01.

TROUBLE SHOOTING

There is not much in this mode that can cause problems and, more often than not, these pages will be used to actually solve any **MIDI** problems you may have.

The most basic MIDI problem you will encounter is that, despite the fact that your **MIDI** connections seem to be correctly set up, you are not getting a sound. To check on this, the following procedure is recommended.

Firstly, go to Page 03 - the incoming **MIDI** data monitor and play a few notes on the connected **MIDI** controller. Make a note of the incoming data and go back to Page 01 using the Page up button. Here, check that the **MIDI** receive channel is set to match the channel being transmitted by the controller or that OMNI is switched to ON. If everything matches up o. k. and you are still not getting a sound, then the problem is more likely to be with the audio side of things (i. e. a broken lead, faulty amplifier, volume turned down, etc.).

If you are using a MIDI controller that transmits **MIDI** control 7 (volume) go to Page 04 to check whether or not the 5950 is set to respond to this. If it is set to ON and you are getting no sound, it could be that your keyboard has remotely turned the 5950 down with its **MIDI** volume control.

If you are not able to use pitch bend on the 5950, check that the pitch bend wheel range on Page 04 is set to something, other than 00. If it is, then the fault lies in the **MIDI** controller.

If the 5950 is not responding to program change over **MIDI**, check that it is set to respond to this on Page 04. If it is not, switch it to ON. If the problem still persists, then, once again, the fault lies in your MIDI controller. Alternatively, it could be that the **MIDI** program number has not been correctly matched in Page 02 of **EDIT PROGRAM** (see **EDIT PROGRAM** for more information).

If you are sequencing the 5950 (but not multi-timbrally) you may get the following problems.

1. The 5950 is playing ALL the parts. If this is the case, go to Page 01 of **MIDI** where you will find that **OMNI** is switched to ON (i.e. it is responding to ALL the incoming **MIDI** channels simultaneously). You should switch this to OFF and make sure that the S950's **MIDI** channel matches the one you wish the part to play on coming from the sequencer.

2. The 5950 is not playing the correct musical part. Go to page 01 and ensure that the **MIDI** channel matches the one you wish it to play.

If you are sequencing the 5950 multi-timbrally, you may encounter the following problems:

1. The 5950 is playing all the parts but in a confused manner. The problem here is that you have set the S950's basic receive channel and set the various keygroups up correctly using the **MIDI OFFSET** function on Page 16 of **EDIT PROGRAM** but **OMNI** is switched to ON. Go to Page 01 of **MIDI** and switch **OMNI** to OFF.

2. The S950 is playing multi-timbrally but is the wrong parts. Here you have probably set the wrong base **MIDI** channel so that **MIDI** offsets are all wrong. To change this you can either change the S950's main receive channel on Page 01 of **MIDI** or you can go to Page 16 in **EDIT PROGRAM** and change the **MIDI** offset parameters. As you would imagine, the former suggestion is the easiest!

UTILITY MODE

This button allows access to programming the Akni ME35T Audi-MIDI converter which allows you trigger samples from audio sources or drum pads. The most common application of this is to use microphones on a drum kit to trigger drum or percussion samples. This would necessitate each drum having its own microphone each of which would be used to trigger the samples. Another similar application is to use drum sounds on a multitrack tape to trigger samples in the 5950 to replace drum sounds on tape. Yet another application is to use the individual audio outputs of a pre-MIDI drum machine to trigger S950 drum samples. Alternatively, simple dram pads can be used to create a powerful sampling drum kit.

To use the ME35T, the MIDI OUT of the 5950 must go to the MIDI IN on the ME35T and the MIDI OUT of the ME35T must be connected to the MIDI IN of the 5950 as shown below.

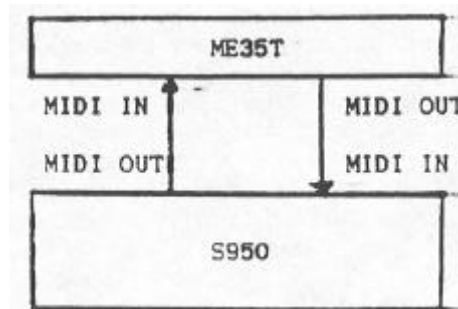

The first page you encounter when you press UTILITY reads:

```
>01 ME35T Audio trigger to MIDI unit
    *Send Settings-          *Read Settings-
```

In this mode you can either send parameters set up on the S950 to the ME35T or you can receive settings from the ME35T for further editing in the 5950 by moving the cursor to the appropriate field and pressing *ENT*.

The parameters available for editing are displayed on the next pages:

```
>02 #Input tMIDI Pitch fOnTime fV-curve .
      1      1 C3  60  30  3
```

and these parameters are as follows:

Input: This is the audio/pad input channel <1-8) currently 'selected for editing.

MIDI: This is the ME35T's MIDI transmit channel. This must match the 5950's. Alternatively, if each pad has its own MIDI channel, then each keygroups MIDI channel must be set to match this using the MIDI offset function on Page 16 of EDIT PROGRAM.

Pitch: This is the MIDI note number to be transmitted by the ME35T

OnTlme: This allows you to set the duration of the MIDI note transmitted by the ME35T. Normally, for drum sounds, this is kept short but with longer settings, you can sustain non-drum sounds for special effects.

V-Curve: This allows you to choose from between 8 velocity response curves to match your own playing technique to the ME35T's triggering functions.

Page 03 displays further parameters:

```
>03 #Input  #Capture time  #Recovery time
      1           3 mS           20 mS
```

These parameters relate to the following functions:

Input: This selects the required audio/pad input channel for editing.

Capture time: This sets in milliseconds the time before another input signal can retrigger a sample. This is useful for preventing accidental flammings and retriggering.

Recovery time: This sets the time in milliseconds of the time it takes for the trigger envelope to settle down.

The next page displays the following parameters:

```
>04 (Input 1 *Gain 50 -(Trig thresh 25
##### T
```

and these parameters are as follows:

Input: Again, this selects the incoming audio/pad channel for editing.

Gain: This sets the level of the incoming signal which is shown in the lower half of the display (##at####) as a bargraph meter.

Trig thresh: This sets the threshold above which samples on the S950 will be triggered.

All these pages' parameters are selected and edited in the usual way. Move the cursor using the 'cursor 7.and/or <' buttons to the appropriate field and input data using the CONTROL wheel or the blue keypad.

All parameters set here can be stored to disk along with the samples, program and MIDI information.

Note: for further information on the hfE35T's parameters, please refer to Its manual.

DISK LOADING AND SAVING - THE DISK DRIVE

This is a very important part of the Akai 5950 as it allows you to load sounds for playback and editing. It also enables you to save the fruits of your labours onto disk. Because the S950 will lose the contents of its memory when power is switched off, we cannot stress the importance of saving your work to disk. Also, it's a good idea to periodically save your work to disk in the event of accidental power loss or unforeseen problems.

The 5950 allows you to use both double density (DD) and high density (HD) disks. The basic 5950 without memory expansion allows you to store a complete memory's worth onto one DD disk. If you have a memory expansion board fitted, you will either have to spread the memory's contents over 2 or more DD disks. This is quite an acceptable practice but it can become tedious when you have to load as many as three disks to fill the 5950's memory. Better still would be to use HD disks with their extra storage capacity. Of course, the best method of storing sounds is to use a hard disk drive. Not only would this allow you to store vast amounts of sounds but loading and saving samples takes a fraction of the time of a normal floppy disk.

As well as being possible to load any disk from the large 5900 library, it is also possible to load S1000 disks into the 5950 so that you can use the fabulous library created for that instrument.

Insert a disk into the disk drive and press the DISK button and the first page displayed reads as follows:

```
>01 VOLUME #Slct,create Floppy      S#x##  
fHDcontl #Hdrivel   Rename Floppy   76%
```

This page does two things. Firstly, in the top right corner (S####> it shows whether an S900 or SI000 disk has been inserted and the bottom right hand of the display shows that disks contents as a percentage-of the S950's memory capacity.

Note 1: If a disk is not Inserted when you press DISK the display will show:

```
OOPS! Disk not mounted .....
```

end all red lights above the mode buttons will flash. To stop this, either press another-of the mode buttons CI, e. PLAY, EDIT SAMPLE, EDIT PROGRAM or whatever) or insert a disk end press DISK again.

Note 2: If an S1000 disk is inserted, the memory percentage display may show a percentage value higher than 100%. This will indicate that the contents of the disk are larger than the S950's internal memory capacity. You can load such a disk but not all the contents will load end when the 5950 is full, the display will show:

```
OOPS! Memory sample space is full .....
```

end the red lights above the mode buttons will flash. To exit this, simply press PLAY where you can select the required programs.

Note 3: The 5950 loads all programs first. If you use an S1000 disk, it could be that the 5950 will load all the programs but the samples relating to those programs may not be loaded. If this happens, when you go to PLAY, you will be able to choose any of the many programs but not all of them will make a sound because the samples contained within them are not present.

Note 4: If the memory expansion boards are fitted, the percentage display changes as appropriate. For example, a full DD disk on an un-expanded 5950 will show 100x. If the full complement of memory expansion boards are fitted so that the internal memory of the 5950 is three times as large, the same disk would display 33x.

The rest of this page is unused unless you have the ATARI/SUPRA HARD DISK and CD/DAT INTERFACE BOARD (IB105) installed and the remaining facilities on this page relate to hard disk control. We suggest you refer to the documentation of the IB105 for further information on these functions.

Page 02 displays the following:

```
>02 (Clear mem i: load disk (1), Mem
0',G
Load disk (2), Clear prev <3> - Vol ##x
```

where ##x is the amount of data on the inserted disk relevant to the 5950's internal memory capacity.

The most commonly used function here is ' i' - Clear memory and load disk. This will erase anything currently in the 5950 and fill it with the data on the disk. After loading, the 'Mem' field will display what percentage of the 5950's memory is used.

The other options are as follows:

Load disk <2> - this will load the disk and but will not erase any of the 5950's current memory. This feature also allows you to load a disk while playing a sound currently selected in memory. Of course, there are limitations to this function. For example, if the 5950's memory is already 100% full, it is not possible to load any further sounds into it. If this happens, the memory displays:

```
MEMORY FULL. Press (3) to clear previous
and continue loading or cancel (ENT)
```

and you can now press 3 on the keypad to wipe the original data in the 5950 and load the new disk or press the ENT button to cancel that situation. Either will take you back to Page 02 of the DISK pages.

To select either mode 1 or 2, move the cursor one position to the right and press either 1 or 2 on the keypad.

Note: as mentioned above, the disk loads programs first followed by samples. In this instance, it could be that the programs are loaded but without their respective samples. Selecting such a program will result in no sound being heard.

The next page allows you to load either an individual program or an individual program with its relevant samples. Press the 'page down' button and the display will show:

```
>03 LOAD PROGRAM (ENT) #PR only _ M Ox
    *name *#####~R APR 3 samples
```

where ##### is the currently selected program name.

This page is invaluable as it allows you to use a program off disk and load that without its samples to use as a template for a program using the samples currently in the 5950's memory.

For example, you may have a selection of drum samples which you have just taken. Instead of creating a new drum program from scratch, you can load another drum program off disk and then place the new samples into the relevant keygroups. That can then be saved onto another disk. In this way, it is possible that you will only ever create one drum program from scratch and use that as the basis for all other drum samples you take!! Of course, this facility is also useful with other instruments, especially intricately mufti-sampled instruments such as piano, etc..

The other use of this page is to load individual programs with their samples so that you can create a new disk which !s an amalgamation of programs from other disks. This is especially useful for live work. where all the required programs and samples can be placed on one disk for easy access with no unnecessary and time consuming loading in between songs or it can be useful when doing pre-production for a studio session.

To select a program to load, move the cursor to the 'name' f field and use the CONTROL knob to scroll through the programs on disk. Having made your selection, move the cursor to either the 'PR only' or 'PR 8 samples' field as appropriate and press the ENT button. The contents of that program will then be loaded into the 5950. Naturally, if the 5950's memory is full, the display will read the usual 'OOOPS! Memory space is full' message.

The next page is similar to Page 03 except that you can select individual samples to load. The display reads:

```
>04 LOAD SAMPLE (ENT)                Mem Ox
    name #####                       *All samples _
```

where ##### is the currently selected sample.

This page is also invluable in making up programs that are a mixture of many different samples off different disks. You may, for example, be using a drum program but prefer the snare on another disk to the one currently in that program. Using this page, you can 'grab' a sample off another disk and then insert i t in the new program. Of course, this is true of any program, not just drums.

To load a single sample, move the cursor one position to the right so that it is in the 'name' field. You can scroll through the samples on that disk using the CONTROL knob and then, once you have made your selection, you can hit ENT and it will be loaded into the 5950.

This page also allows you to load all the samples on a disk into memory but without the program information. To do this, move the cursor one more position right to the 'All samples' field and press ENT - this will load all the samples on that disk into memory.

Once again, if there is insufficient memory space in the S950, the display will give you the usual 'OOOPS! Memory sample space full' message.

The next pages are concerned with SAVING data onto disk.

Page 05 allows you to wipe a whole disk and save the entire contents of the S950's memory onto it. The display shows:

```
>05 Clear volume and save      Mem Ox
      entire memory            Vol 76%
```

The top right percentage display shows the S950's current memory capacity whilst the lower percentage display shows how full of data the disk is.

Note: if your 5950 has the full complement of memory expansion boards, the top right display may only show something like 85x. If you use normal DD disks, this is too much to be stored on one disk even though the percentage display indicates that only 85x percent of the memory is full. Of course, this figure relates to 85x of three times the DD disks capacity. In other words, either use more than one DD disk or use HD disks or a hard disk.

To wipe the disk and save the contents of the S950's memory to disk, simply press ENT but be careful that you are not erasing a valuable disk as there is no stopping this procedure once it has been initiated.

The next page allows you to save individual programs with or without their respective samples onto disk. The display reads:

```
>06 SAVE PROGRAM (ENT) 1PR only _      Vol
      #name A~;~k#                    *Pr & smpls _ 764
```

where ###~`# is the currently selected program to save.

To select a program for saving, move the cursor to the 'name' field and use the CONTROL knob to scroll through the programs currently in the S950's memory. Once you have made your selection, move the cursor to either the 'PR only' or 'PR & smpls' field and hit the ENT button. This will save that program onto disk. The .display also shows the disks current memory percentage and this will increase when you save more samples onto it.

The next page allows you to save individual samples:

```
>07 SAVE SAMPLE (ENT)                Vol
      *name ~Y~x~k*~tA~xx              76%
```

where #####f*#;# is the currently selected sample.

As in Page 06, move the cursor to the 'name' field and scroll through the samples until you find the one you wish to save. When you have done that, hit the ENT button and the sample will be saved to disk. The percentage figure displays the disks current capacity and will increase as you save more samples.

It is also possible to erase samples or programs off disk and this is done on Page 08.

```
>08 ERASE FROM *Sample           Vol
      VOLUME (ENT)  *Progrm ~-at~R~ 76%
```

To erase a program or sample, simply move the cursor to the appropriate field using the 'cursor >' button and, using the CONTROL knob, scroll through the programs or samples on disk until you find the one you wish to erase and then press ENT which will erase it from the disk. Of course, it goes without saying that you should be careful here so that you don't erase anything precious: The percentage display will decrease as samples are erased from the disk.

The next page is concerned with formatting a floppy or hard disk.

Any 3.5 inch double density (DD) or high density (HD) disk can be used with the S950 but, before it can be used, it has to be formatted so that it is compatible with the S950's software. Hard disk drives also need to be formatted and all this is done on Page 09.

```
>09 (Format floppy _ Format SH204/5 _
      Wipe hard disk _      Total free  34%
```

To format a floppy disk (i.e. a 3.5 inch DD or HD disk), move the cursor one position to the right using the 'cursor >' button and press ENT. The S950 will now format the disk and the the display will slowly fill up with two rows of dots as the formatting process takes place. When the display is full of dots and the red disk activity light goes out, the disk is ready for use.

The other funtions are all concerned with the optional ATARI/SUPRA HARD DISK INTERFACE (IB105) and you are advised to refer to the documentation that accompanies the IB105 for further information.

IMPORTANT NOTE: FORMATTING A DISK WILL ERASE IT'S CONTENTS ENTIRELY ° THIS IS TRUE OF BOTH FLOPPY AND HARD DISKS. ALWAYS ENSURE THAT YOU USE A BLANK DISK OR ONE THAT YOU WANT TO ERASE.

Page 10 allows you to load and save drum settings for use with the ME35T. The display shows:

```
>10   Load drum settings (ENT) _ Vol
      *Save drum settings (ENT) _ 76%
```

To load a drum setting, move the cursor to the first field by pressing the 'cursor >' button once and pressing ENT. To save a drum setting, move the cursor one further position right and hit ENT.

Note: Only one ME357 drum setting can be stored on disk and any other settings on that disk wJ1J be overwritten by the new settings you wish to save. Make sure, therefore, that you either use a new disk or that you are happy to overwrite the existing drum settings.

In any of the pages 05 to 10, when you try to save anything onto a disk or format a disk that has been write-protected the display will read:

OOPS! Disk is write protected. Take it
out and close the switch in the corner

and all the mode lights will flash. This is telling you that you cannot save onto this disk because the tab in the bottom left of the disk has been opened. By closing this tab, you will be able to save to disk and format. It is a good idea to write protect your disks at all times to prevent accidental erasure of precious programs or samples.

Page 11 allows you to load sounds from the hard disk using MIDI program change. The display reads:

)11 MIDI program changes can now load
hard disk volume. Floppy number 0

The volume number attached to the RENAME FLOPPY function on Page 01 of disk when used to save data to the hard disk can be set to correspond to a MIDI program number so that pressing the required program number on the MIDI controller will initiate a disk load where the equivalent contents of one floppy disk's worth of data will be loaded from the hard disk. Please refer to the IB105's documentation for further information.

The final page in DISK allows you to park the hard disk drive's head making it safe for transportation. The display shows:

)12 Park hard disk, (ENT). This makes
it safe for transportation.

To execute this function, simply hit the ENT button. Of course, this function does not apply if you are not using the hard disk option.

That concludes our examination of the DISK functions. As always, the whole thing is structured to be very easy to use but, even then, mistakes can still be made. Try to bear the following things in mind when using the disk drive.

1. Always keep a track of what you are doing when using the DISK mode. It is all too easy to be distracted and accidentally load a disk and wipe the memory instead of saving hours worth of work to disk. Even full time professional programmers have been known to do this!!
2. Be very careful with Page 05 that you don't accidentally wipe the entire contents of an important disk when saving data. Always check the disk before you save any data - this can be done on Page 03 where you can scroll through the programs on a disk.
3. Similarly, be careful you don't bulk erase an important disk when formatting.
4. Make sure that you don't accidentally erase the wrong data from disk on Page 08.

DISK HANDLING

Disks are very important pieces of equipment for anyone who owns a sampler and they represent many hours of work. As a result, it is important that you take good care of your disks to ensure reliable operation.

Always use branded, high quality disks. Failure to do so may result in corrupted data on the disk preventing it from loading properly. Cheap disks can also damage the heads and we cannot guarantee reliable operation.

Always insert disks straight into the drive, then gently push them all the way in. Trying to force them into the drive may damage the disk or the drive.

Never bend a disk or store them in a position that is likely to apply pressure to their cases.

When labelling floppy disks, we recommend the use of felt tip pens. Writing on disks using ball point pens and pencils can exert undue pressure on their cases.

Always take care when physically handling your disks. Never pull the protective metal tab on the top of the disk's case back and touch the actual disk inside as your sweaty fingers will harm the delicate disk surface.

Always keep your disks away from magnetic sources such as speaker cabinets, TV sets and video monitors, heat and direct sunlight.

Do not keep the disks in a vehicle for any length of time. Not only will this will prevent damage from temperature changes and excessive sunlight but will also reduce the risk of theft.

Always keep disks away from drinks and food in case of accidental spillage.

Always try to keep backup copies of all your disks in case of loss, theft or damage.

When transporting your disks, try to ensure that they are kept in a solid case. Not only will such a case protect them whilst in transit, these disk boxes also allow you to keep your disks in some form of logical order and will save wasted time hunting for particular disks. If you are 'on the road' doing live shows, it is a good idea to use a flight cased briefcase container for transporting your disks.

If you are travelling abroad with your disks, never let your disks pass through a security X-ray machine as these can damage your disks irreparably. It is a good idea to keep your disks as hand luggage to **prevent** airport officials accidentally putting them through X-ray machines. Most security officers will comply with your request to keep them away from X-ray machines as long as you allow them to search the case themselves.

If you are posting a disk, wrap it in kitchen foil to prevent stray X-rays from damaging the disk. Also, wrap the disk in solid cardboard and a padded envelope to prevent it from bending - you can buy special cardboard containers for posting disks and these are recommended. Also label the envelope 'CAUTION - COMPUTER DISK ENCLOSED' and the postal service will take good care of it. If the disk is valuable, it is a good idea to send it recorded or registered delivery.

Note: If your disk is damaged in any way and the disk drive is unable to load the data, the 5950 will display:

OOPS! Bad data from disk

and all the red mode lights will flash.

If this happens, it may not be as bad as you think because it is quite possible for just the last sample or the last few samples on a disk to be corrupted and the rest of the disk may have loaded successfully.

MASTER TUNE

Without doubt, this is the easiest mode to understand and it is here that you can tune the S950 to different instruments.

To tune the S950, press MASTER TUNE and use the CONTROL knob to adjust pitch up or down so that it is tune with other instruments. And that's it!

,Vote: If the tuning range in this page is not wide enough, you can tune samples up or down in either Page 03 of EDIT SAMPLE or in Page 06 of EDIT PROGRAM and these tunings can be saved to disk.

APPENDIX

5950 - K4IIKREF PROCEDURE
CHART.

As we have seen throughout this manual, every mode within the 5950 has a default value. All of these have been sensibly chosen so that you can get on with your work with the minimum of button pushing and data entry. What follows now is a quick reference chart that will guide you through the most

```
=====
| PLAY MODE - Playing a sound |
=====
| STEP 1 | Press PLAY and use the CONTROL knob to scroll through programs. |
-----
| STEP 2 | Type in a one or two digit number on the blue keypad to call a |
|         | program for playing. |
-----
| STEP 3 | Play a note on the connected MIDI controller to hear the sound. |
=====

=====
| REC MODE - Sampling on the S950 using the mic or line inputs |
=====
| STEP 1 | Press REC and name the sound to be sampled. |
-----
| STEP 2 | Go to Page 04 - type in a bandwidth using the blue keypad. |
-----
| STEP 3 | Go to Page 05 - set the sampling time using the keypad. |
-----
| STEP 4 | Go to Page 06 - select the key you wish to sample onto by |
|         | playing a note on the MIDI keyboard or controller. |
-----
| STEP 5 | Go to Page 08 - set the record level and threshold level. |
-----
| STEP 6 | Make your sample and play it from the connected MIDI controller |
|         | or hit PB. |
=====

=====
| EDIT SAMPLE MODE - editing and looping a sample |
=====
| STEP 1 | Press EDIT SAMPLE and select the sound to be edited. Copy or |
|         | rename if necessary. |
-----
| STEP 2 | Go to Page 04 - select replay mode (i.e one shot, looping or |
|         | alternating) using the keypad. |
-----
| STEP 3 | Go to Page 06 - edit the start point if necessary. |
-----
| STEP 4 | Go to Page 07 - edit the end point if necessary. |
-----
| STEP 5 | Go to Page 08 - set an arbitrary loop length (i.e 3,000) and |
|         | hit ENT to initiate the AUTOLOOP. Repeatedly hit ENT until a |
|         | useable loop is found. |
-----
| STEP 6 | Play the sound from the connected MIDI controller or hit PB. |
=====
```

```

=====
| EDIT PROGRAM - refining your samples
=====
| STEP 1 | Press EDIT PROGRAM and create a new program by copying the
|         | currently selected program.
-----
| STEP 2 | Go to Page 03 - Copy or delete keygroups as necessary using
|         | the ON (+) or OFF(-) buttons.
-----
| STEP 3 | Go to Page 05 - Select keygroup and place the appropriate
|         | sample in it using the CONTROL knob. Assign the low and high
|         | keys if necessary.
-----
| STEP 4 | Go to Page 06 - Adjust level, filter and tuning of keygroups
|         | if necessary.
-----
| STEP 5 | Go to Page 10 - Adjust envelope shape for keygroup(s) if
|         | necessary
-----
| STEP 6 | Go to Page 13 - Adjust LFO parameters for keygroup(s) if
|         | necessary
-----
| STEP 7 | Play the sound using the MIDI controller or hit PB.
=====
| NOTE: IF YOUR PROGRAM HAS MORE THAN ONE KEYGROUP, EXCEPT ON PAGE 05,
| YOU MAY LIKE TO ADJUST ALL KEYGROUPS SIMULTANEOUSLY BY SWITCHING THE
| KG FIELD TO 'ALL'.
=====

```

```

=====
| MIDI - Setting the S950's MIDI parameters
=====

```

```

| STEP 1 | Press MIDI and set OMNI to ON or OFF and set base MIDI channel
|         | as required.
-----
| STEP 2 | Go to Page 04 and set Loudness, Prog Change and Pitch Bend as
|         | appropriate.
=====

```

```

=====
| DISK - Loading and saving data using the disk drive
=====

```

```

| STEP 1 | INSERT DISK - Press DISK.
-----
| STEP 2 | To load a disk:
|         | Go to Page 02 - Move cursor right and hit 1 on the keypad.
-----
| STEP 3 | To save the entire contents of the S950's memory to a disk:
|         | INSERT A BLANK FORMATTED DISK - Press DISK - Go to Page 05 and
|         | press ENT
=====

```

```

=====
| MASTER TUNE - tuning the S950 to other instruments
=====

```

```

| STEP 1 | Press MASTER TUNE and use the CONTROL knob to tune the S950 up
|         | or down as appropriate.
=====

```

FOR MORE SPECIFIC FUNCTIONS IN ALL THESE MODES, PLEASE REFER TO THE RELEVANT SECTION OF THIS MANUAL

5950 - OPTIMUM BANDWIDTH KWIKREF CHART

The 5950 has a continuously variable bandwidth. As a result, it is possible to sample each and every sound with a different bandwidth thereby optimising the sound quality and available memory. This KWIKREF chart lists the optimum bandwidth of a variety of commonly used sounds. Using this as a guide to your own sampling will enable you to get more samples into the S950.

INSTRUMENT	OPT B/W	INSTRUMENT	OPT B/W	INSTRUMENT	OPT B/W
Kick drum	10k	Bright snare	16-18k	Crash cymb	17-19k
Clicky kick	12k	Woody snare	14-16k	Ride cymbal	15-17k
Round kick	8-10k	Round snare	14-15k	Splash cymb	17-19k
Gated kick	10-13k	Gated snare	15-18k	Hi-hats	16-19k
Toms	13k	Congas	13-15k	Synth Snare	14-16k
Deep toms	11-12k	Timbales	14-16k	Synth Kick	10-13k
Stick toms	13-15k	Octabans	12-14k	Synth Toms	12-15k
Cabasa	14-16k	Cowbell	12-15k	Rimshot	12-14k
Claves	12-14k	Agogo bell	13-14k	Side stick	12-14k
Claps	12-15k	Vibraslap	14k	Brush Snare	12-14k
Maracas	13-14k	Whistle	13k	XXXXXXXXXXXXXXXXXXXX	
Bass guitar	10-12k	Acoust guit	12-14k	Piano	14-16k
Slapped bass	13-15k	Nylon guitar	10-14k	Rhodes pno	12-14k
Synth bass	12-15k	Elect guitar	12-15k	FM Rhodes	14-16k
Upright bass	10-12k	Distorted gt	13-15k	Clavinet	12-16k
Fretless	10-12k	12 str guit	13-16k	Organ	12-16k
Violin	14-16k	Oboe	14-16k	Trumpet	14-17k
Viola	12-14k	Clarinet	14-16k	Muted trump	15-18k
Cello	11-13k	Bassoon	12-14k	French horn	13-15k
Contrabass	10-12k	Flute	12-14k	Trombone	12-16k
Soprano sax	14-16k	Alto sax	13-15k	Baritone sx	12-14k
Vibraphone	16-18k	Tubular bell	15-17k	Voice	12-14k
Marimba	14-16k	Gong	13-15k	Mixed choir	12-14k
Xylophone	14-15k	Tympani	12-14k	Female chr	12-14k
Glock/Celest	15-16k	Triangle	15-18k	Breathy vox	12-14k
Digi synth	14-19k	Analog synth	12-15k	Orch strike	14-19k
String sect	14-16k	Brass sect	14-17k	Sax section	14-16k

You will note that these bandwidth figures are approximate. Of course, you may require higher or lower bandwidths than those shown for certain instruments - it all depends entirely on the tone of the instrument you are sampling. If it is bright, It may require a higher bandwidth than the **one recommended** but if the sound is relatively mellow, you might like to try a lower bandwidth setting. The best thing to do is experiment. Take a sample at your selected bandwidth and play it back from the MIDI controller comparing it with the original. If it sounds a bit muffled, try a higher bandwidth but if it sounds good, save that sample and try taking another at a lower bandwidth to see if you can save even more memory. If the results of that don't sound too good, recall the original.

Note: to save even more valuable memory in your 5950, don't forget the DISCARD BEFORE START/AFTER END function on Page 10 of EDIT SAMPLE.

ADVANCED APPLICATIONS

We have now covered the basic operation procedures on the 5950 but there is so much more that we can do with samples and programs once they are in the instrument. This section will take you through some of the more advanced possibilities available on the 5950. In EDIT PROGRAM you can create all sorts of keyboard splits and layering effects and the various processing possibilities allow the creation of chorus and other effects.

CREATING A SPLIT KEYBOARD

Sometimes it is desirable to have two separate sounds on the keyboard where, for example, you have a bass guitar sample on the bottom two octaves and a piano sound on the top three octaves. This is easy to achieve and is simply an extension of the multi-sampling procedure where you have a number of samples assigned to different key ranges in keygroups.

To create this split keyboard, create a program with, say, 7 keygroups in it. Move to Page 05 and set the keygroups thus:

```
KG1 - Bass sample - low key C0 24, hi key B2 62
KG2 - Piano C3     - low key C3 60, hi key E3 64
KG3 - Piano G3     - low key F3 65, hi key Ax3 70
KG4 - Piano C4     - low key B3 71, hi key E4 76
KG5 - Piano G4     - low key F4 77, hi key A#4 82
KG6 - Piano C5     - low key 84 83, hi key E5 88
KG7 - Piano C6     - low key F5 89, hi key G8 127
```

You can see that the bass sample covers the bottom octaves to B2 and the multi-sampled piano takes over at C3 up through the top octaves of the keyboard. (This, of course, is only an example - your samples may be different and require different keygroup assignments.)

Another application of this technique is to layer the bass sample over the bottom octaves of the piano. To do this, make a copy of your piano program and simply create another keygroup in Page 03 and assign that from C0 to B2 as above. The only difference here is that the original piano bass notes will sound with the bass guitar sample creating a more forceful bass end.

This keyboard split technique can be extended to include a three way keyboard split with perhaps a bass synth on the bottom two octaves, a string sound over the next two octaves with a lead line sound or some orchestral hits on the top octaves - you could even have a few drums on a few notes (i.e. bass drum on C1, snare on D1, hihat on E1 and a cymbal on F1) with the bass guitar spanning G1 to B2 - the possibilities are almost unlimited.

LAYERING SOUNDS

It is easy to layer samples on top of each other within the 5950 to create rich chorus effects or composite effects.

All you have to do is to make exact copies of keygroups and then, in Page 06, detune them slightly using fine tune.

For example, with a simple string program with just one keygroup, to thicken the sound, simply make a copy of that keygroup in Page 03 and then detune it in Page 06. In a more complicated multi-sample program that has, for example, four keygroups, copy KG1 to create a new keygroup, KGS, copy KG2 so that you create another new keygroup, KG6, copy KG3 so that you create another keygroup, KG7 and copy KG4 to create KGB. Now detune keygroups 5-8 slightly.

Of course, you are not limited to just detuning them slightly as you can use the TRANSPOSE field in Page 06 to split them in octaves or fifths or any other interval.

This layering technique can be extended even further to layer, for example, strings on top of brass. To do this, copy a strings program to create another program such as STR-BRASS or whatever. Now, using the PUT and GET functions in Page 03, place the various keygroups from a brass program into STR-BRASS - the original string sound is now layered with the brass program. Of course, after that, you may choose to detune them slightly or split them in octaves.

It is also possible to layer three sounds on top of each other for an even greater range of possibilities but please note: **LAYERING KEYGROUPS REDUCES POLYPHONY.** WITH TWO KEYGROUPS LAYERED, THE 5950 WILL ONLY BE ABLE TO 'PLAY A MAXIMUM OF FOUR NOTES SIMULTANEOUSLY AND FURTHER LAYERING WILL REDUCE POLYPHONY EVEN MORE, Of course, if the sound you are creating is a solo sound, this needn't be a problem - it's only when you wish to play chords that you may notice some notes missing if the number of notes played exceeds 4.

One interesting layering technique uses the WARP facility on Page 12. Try this.

Using a simple vocal program that has just one keygroup with an 'aaah' vocal sample in it, copy the keygroup and detune one of them so that you now have a richer 'aanah' sound. Now go to Page 12 and on just one of the keygroups, set the display to read:

```
>12 WARP      Velocity 0      fTime 75
*KG1         (Attack offset -50
```

and play a note. You will notice that keygroup 1 slides up to the note whilst the other remains in tune during the attack. This creates an interesting detune effect during the attack portion of the sound. This technique is very useful on vocal sounds as it is normal for there to be a slight pitch slide on 'the real thing'. It is also useful on brass sounds which sometimes have a tendency to slide up into a note. Of course, the settings given above are only an example so please feel free to experiment. You could, for example set longer or shorter warp times or have the pitch sliding down - you could even have one keygroup sliding down and the other sliding up and at different warp times!! You could also use velocity to control the slide. Again, endless possibilities.

USING THE LFO

The low frequency oscillator found on Page 14 is a most useful device. Its prime use is to add vibrato and other pitch sweep effects to a sample in a keygroup but it can have other uses as well.

For example, say you have a sample but the loop is not that good and, despite your attempts to improve it, you still can't get rid of a slight glitch or tremolo effect, you can use the LFO to disguise the effects of this loop by adding some vibrato to that sample. You will probably want to set the LFO so that it is having effect constantly so you will want to set the LFO Depth to around 3 or 4 for a hint of continuous vibrato. The actual LFO rate can be set according to the circumstances and you are advised to experiment. You may find that the action of the LFO masks the slight glitching very effectively. To further disguise an awkward loop, you can layer the sample on top of itself as described above (providing the restricted polyphony is not a problem, of course) and add this slight vibrato effect.

The LFO can also be used when layering sounds to create interesting chorus effects. If you have tried out any of the layering ideas given above, you will have noticed how using the fine tune on Page 06 for a detune effect thickens the sound. This can be further enhanced by setting the LFO depth of just the one keygroup in the layer to a value of around 3 or 4 and leaving the other keygroup in the layer free of any LFO modulation. What you now have is two keygroups layered on top of each other with some slight detune and the one keygroup's pitch is varying ever so slightly to give an 'animated' chorus effect. To further extend this idea, you could give the other keygroup a different vibrato with a slightly slower or faster LFO rate. In this example, you would have the keygroups' pitch shifting against each other creating a rich, warm ensemble sound. This can be even further enhanced by switching DESYNC to ON so that all the LFO's are out of phase with each other.

Using Page 14, you can extend these chorusing effects to be under the control of the MOD WHEEL. By setting just one of the keygroups in a layer to respond to the modulation wheel, you could introduce a chorus effect with the modulation wheel. Of course, aftertouch could also be used for the same effect.

USING THE ENVELOPE GENERATORS

The basic use of the envelope generators is to shape the sound and so restore the natural envelope characteristics of the sampled sound. They can also be used to add unusual envelopes to sounds and one example may be to add a bowing effect to any sound. To do this, set the KG field to ALL and increase the attack time of the envelope generator in Page 10. By setting an instant decay with no sustain level (i.e. sustain at 00>, you can create a curious reversed type sound that is subtly different from actually reversing the sample in Page 05 of EDIT SAMPLE.

The fact that there are envelope generators for every keygroup (and hence sample) in a multi-sample program means that you can set the decay and release times for every sample. It is common for many acoustic instruments to become more percussive the higher up in pitch they go. This is especially true of piano sounds where bass notes can last several seconds whilst high pitched notes die away almost instantly. You can set the decay and release times of each keygroup across the keyboard range to simulate this effect with bass notes having longer decay/release times than higher pitched sounds. You could, of course, set the opposite for special effects.

The same is true of attack times, especially on stringed instruments where a 'cellos attack is longer than that of a high violin note. By scaling the attack times of a group of samples in this way, you can create more realistic string envelopes.

It is also possible to control attack time using velocity and this can be put to a number of expressive uses. For example, you may have a flute sample with a very percussive 'blowy' attack but you may not always want that attack to sound on every note. By setting a long attack and controlling attack time with velocity, playing softly will effectively miss out the percussive attack because of the soft attack whilst harder keystrokes will produce a faster attack time thereby allowing the percussive, breathy attack to be heard. Of course, you can combine this technique with velocity switching for even greater expressive possibilities.

There are other uses the envelope generators can be put to, however.

For example, it sometimes happens that there is some noise at the end of a sample. In actual fact, it may not be that the sample is very noisy, it's just that as the sound dies away, the noise becomes more noticeable. This can be suppressed using the envelope generators by setting a decay or release that roughly matches the sample's decay so that the envelope generator fades out the noise with the sound (see Fig. 1). The filter's envelope generator can also be used for the same purposes and, of course, the two can be used in conjunction with each other.

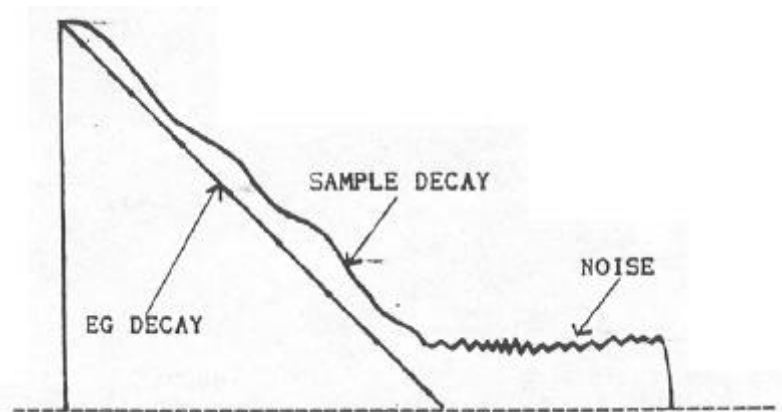

Fig. 1 Fading out noise using the envelope generators

Did you know that you can control reverb time using the envelope generators. By sampling a drum sound with a long reverb you can effectively control the length of the reverb using the envelope generators decay and/or release times. In this way, you could create a number of different drum programs where each program has increasingly longer reverb times on the drums. Also, because it is possible to control release times using keyboard velocity, you could actually control the reverb decay with keyboard dynamics.

When you are layering two keygroups on top of each other you can create interesting crossfade sounds by setting one keygroup in the layer to have an instant attack and the other to have a slow attack. For example, you could have a program where a brass sound crossfades with a string sound. By setting the brass envelope to die away completely (i.e. with a sustain level of 00) the two sounds would completely crossfade. This technique can be more conservative of memory than creating a sample crossfade in EDIT SAMPLE which requires that you create a new sample.

This technique can be extended by layering the same sample on top of itself and then transposing one sample up two octaves and setting the transposed sound to fade in slowly. Alternatively, you could layer guitar feedback effect on top of a distorted guitar sample and have the feedback fade in slowly.

As you will have guessed, there are all sorts of possibilities available when using the envelope generators and we suggest that you experiment to see the sort of effects you can create with even the simplest sample.

USING THE INDIVIDUAL OUTPUTS

On the back of the 5950 are a number of audio outputs. There is the MIX output which, as the name implies, carries a mix of all 8 voices to an amplifier or mixer. The LEFT and the RIGHT outputs allow you to create stereo type effects as well as split keyboard effects and there are also the 8 individual monophonic outputs.

The most basic application for these 8 individual outputs is to handle individual drum samples where each drum can be given its own channel on a mixing desk and EQ'd, balanced and effected separately and how to assign the outputs is explained in EDIT PROGRAM. These individual outputs are monophonic - that is, they can only play one sound at a time so it is not possible to play chords through them. It could be, however, when you are sequencing multi-timbrally using the MIDI OFFSET function found on Page 16 of EDIT PROGRAM that you have chordal parts that you wish to assign to individual outputs. This can easily be achieved on the 5950 using a combination of the individual outputs and the left and right outputs.

As mentioned earlier in this manual, the MIX output carries all the 8 voices regardless of whether they have been assigned to individual outputs or not. The left output carries voices 1 to 4 and the right output carries voices 5 to 8. What this means is that anything appearing at individual outputs 1 - 4 will also appear at the left output and anything assigned to outputs 5 - 8 will also appear at the right output. This allows you to set up a multitimbral situation where polyphonic sounds are assigned to either the left or right outputs with monophonic instruments being assigned to 4 of the individual outs respectively.

For example, say you wanted to sequence some drums, a bass and a piano part on different MIDI channels from a sequencer. You could assign the bass drum to individual output 1, the snare to individual output 2 and the closed and open hi-hats to individual output 3. The bass sample *which is* only playing monophonically can be assigned to output 4. The piano part can then be assigned to the right output for polyphonic playback. Conversely, if it is more appropriate, the drums and bass could be assigned to individual outputs 5 - 8 with the piano coming out of the left output (remember that individual outs 1 - 4 appear at the left output and outputs 5 - 8 appear at the right output so these can't be used together successfully). To sequence more instruments, you would have to carefully plan your output assignments but a lot can be done so long as too many sounds don't appear together. For example, the snare output could share with a clap or rimshot as long as they don't sound on the same beat. Similarly, the bass drum could share a cabasa or whatever as long as they don't sound on the same beat. The left or the right output, depending on which you are using, could share with a brass sound or a string sound as long as the total polyphony for this output does not exceed 4 notes at any given time. With careful planning of output assignment and great attention paid to the orchestration of your sequencing, you can achieve astonishing results.

Of course, you may not have access to a mixer and so you will want to use the MIX output. If this is the case, you can mix the various instruments and control tone in Page 06 of EDIT PROGRAM.

Note: however you sequence your 5950, ensure that total polyphony never exceeds 8 voices at any time. In particular, take care if you are using any layered programs as *these will* reduce the available polyphony of *the* sampler.

USING THE 5950 WITH ANOTHER SYNTH

Using **MIDI**, it is possible to layer the S950 on top of sounds generated by another synthesizer. This can be very useful in enriching the sound of either the synth or the sampler.

For example, you may have a synthesized string sound which needs some extra 'detail' to add more realism. By layering a nice 'bowey' string sound, you not only create a richer sound but you also add that extra bowed detail. By EQ'ing each sound and carefully balancing the two together on a mixer, you can enhance the sound even further and a touch of reverb will add the finishing touches. The same technique applies to any other combination of sounds. Of course, the sounds don't have to be the same - french horn and glockenspiel is a nice combination as is piano and strings with the synth or the sampler providing either sound. Combining sampled sax with synth brass and then splitting them in octaves with some slight WARP on the S950 can create a powerful brass section whilst combinations of sampled voices and synth sounds allow you to produce beautifully ethereal textures.

One popular technique these days is to graft the attack of a sampled sound onto a synth sound and this too can be particularly effective and layering just the attack of a violin onto even the most lack-lustre synth string sound can create a very realistic hybrid. The 5950 can be used to do this very easily and the beauty of using the 5950 in this way is that you can layer your own samples on top of your own synth programs and not rely on factory preset samples and programs as is the case in the synths that utilise this technique. Once again, with the right balancing, EQ and judicious use of effects such as reverb, some astonishing textures can be created and the advantages of this method of layering just sampled attack transients is that these transients take up very little memory in the 5950 and one disk could easily hold a few string, brass, breath and percussion attacks to layer over your synth sounds in a myriad of combinations.

If you are working live, you will probably want to recall these samples with the synth programs. This is easily achieved by assigning any given program on the S950 to be recalled via MIDI program change using the 'MIDI prog' function on Page 02 of EDIT PROGRAM. So, if your synth string program is number 37, assign **MIDI** prog 37 to your sampled string attack transients and the samples will be recalled whenever you select the string sound. If you want to layer those same samples on top of another sound in another memory location on your synth, simply copy the program in the S950 giving it a slightly different name (why not give it the same name as your synth sound?) and assign the appropriate **MIDI** prog number to the copied program.

Naturally, all this needn't relate only to keyboard control and it is possible to layer 5950 drum samples on top of a drum machine's drum sounds to create powerful modern drum hybrids. Similarly, a **MIDI** drum kit could be used with the sampled sounds layered on top on the distinctive analogue synth drum sounds these electronic kits are famous for. Likewise, layering samples over your MIDI guitar can create extremely interesting effects.

USING MIDI VOLUME CONTROL ON THE S950

There exists in the MIDI specification a special MIDI control code number 07 which allows you to remotely control the volume of the 5950 from another MIDI controller. This can be switched in and out using Page 04 in the MIDI mode. This has a variety of uses.

Firstly, you can use a MIDI footpedal to control volume. Assuming your synth or MIDI keyboard has such a facility, you can simultaneously control the volume of both the 5950 and the synth using the footpedal. This can be extremely expressive on string sounds where you can create crescendo and swell effects.

Another use is simply to remotely control the output volume of the 5950 if it is stuck away in rack out of harms way but perhaps the most powerful use of this control is when you are sequencing multi-timbrally because you can mix the various parts using the MIDI volume control.

Assuming you have a multi-timbral set up programmed using the MIDI offset function found in EDIT PROGRAM, go to the MIDI button and ensure that the parameter LOUDNESS is switched to ON - the S950 is now set up to respond to MIDI control 07. Now create a multi-channel sequence on your MIDI sequencer. Having done that, overdub a MIDI volume control setting on, say, MIDI channel 1 using the appropriate data entry facility on your synth or keyboard. You will note that only the instrument assigned to MIDI channel 1 on the 5950 changes volume as you move the data entry slider whilst the other instruments don't change volume. Furthermore, that data entry slider movement can be recorded into your sequencer. You will be able to do this for all tracks and instruments, fading sounds in and out gradually thereby creating a flexible automated mixing facility that would embarrass even very sophisticated mixing consoles!!

Note: all this depends on the capabilities of your particular synth or keyboard controller and sequencer. It could be that your synth has no way of generating MIDI control 07 or, alternatively, your sequencer may not be able to actually record it. This is for you to establish with your own equipment set up. Having said that, most synths, keyboards and other MIDI controllers do generate MIDI control 07 and most sequencers allow you to actually record that control data as part of a sequence so all this should be no problem.

USING THE MONITOR SELECT

In REC and EDIT SAMPLE, Page 02 has a facility whereby you can monitor the sound you are sampling or the sample you are editing in the context of a program. This can be very useful if you are doing any multisampling or if you are sampling or editing drums.

To monitor, for example, a new snare drum sample in conjunction with other drums in a program called DRUMS 1, go to Page 02 of the REC mode and, using the CONTROL knob, scroll through the programs and select DRUMS 1. You will now be able to hear your new sample in conjunction with the other samples in the program.

The same is true of EDIT SAMPLE. If you want to hear how your edits sound within the context of a program, go to Page 02, select the appropriate program using the control wheel and you will hear the sample currently selected for editing with the **other samples in that program.**

Note: before you can do this, the program has to have been created and the sample name used in *REC* or the sample currently selected for editing has to have been placed within that program. For example, if the sound you are sampling or editing is called *SNARE 1* but the program *DRUMS 1* does not contain that name in any of its keygroups, you will not be able to effectively monitor the sample you are working on.

EDITING A THE START POINT OF A SAMPLE - a useful tip

It is often necessary to trim the start points of a sound to eliminate any extraneous noises that may have crept in before the sample. This is easy enough to achieve and is described in *EDIT SAMPLE*. With some sounds, particularly percussive sounds and, in particular, drums and percussion, the start points must be very accurately set otherwise the samples may start late and affect the 'feel' of a piece of music. These days, especially with dance and pop music, rhythmic perfection is extremely important and if drums are late by even a few milliseconds, the quantised perfection of your sequenced parts falls apart. The problem is, even the most critical ear and the S950's *AUTOMATIC START POINT* function is sometimes not accurate enough to detect a slight delay so here's how to set the start points more accurately.

Go into *EDIT SAMPLE* and select the sound you wish to edit. Let us assume that it was sampled at C3 60. Ensuring that Page 02 is set to 'Monitor', play the selected sound on C1 on your keyboard so that it is playing two octaves down. When you do this, you effectively slow the sample down and any slight delays at the start point will be accentuated. Move the start point until there is no delay - you will find that samples edited in this fashion are much tighter in a strict tempo piece of music.

If you are not using a keyboard to play your samples, you can use the PB button and the sample can be transposed down two octaves using Page 03 of *EDIT SAMPLE*. The same applies if you are using a drum machine or drum pads to trigger the sample.

Naturally, this doesn't only apply to drum or percussion sounds - any sample will benefit from this technique.

SAVING MEMORY IN THE 5950

One of your main concerns if you are trying to cram as many sounds into the 5950 as you can is to make economic use of memory. The 5950 has several features that makes such a thing easy.

To begin with, always select the optimum bandwidth for the sound you are sampling. It's all too tempting to sample everything at full bandwidth to ensure that the sound is crystal clear but this is wasteful of memory, especially on sounds that would not benefit greatly from the increased bandwidth. For example, what is the point of sampling a bass drum at full bandwidth when it is unlikely that there will be many frequencies much above 10kHz - it would be better to sample it with a 10k bandwidth to save memory. By adopting this approach for every sound you sample, you'll be amazed at how many samples you can squeeze into the 5950.

It is also important not to waste sampling time 'so select your sampling time in *REC* mode carefully. This is not a big problem, however, as you can always shorten the sampling time if it's too long by changing the end point in *EDIT SAMPLE*. By going to Page 10 of *EDIT SAMPLE*, you can discard the unwanted end point and free up more memory.

You can also edit the end point on looped sounds without affecting the loop in some cases.

Let us say that you are editing a sample and have effectively looped it in Page 08. You can now go back to Page 07 and move the end point back. Play the sound repeatedly as you edit the end point and you will find that you will be able to edit out quite a large chunk of the sound before the loop is affected. You can now go to Page 10 and discard the unwanted portion of the sample. Of course, this won't always work 100% because of the nature of some sounds but it is something you can experiment with - if it doesn't work, revert to the original end point.

Hopefully, all this should give you an insight to the amazing creative possibilities offered by the Akai 5950 and we hope also that it will act as a catalyst for you to experiment and create and edit your own samples and programs. Naturally, there is a large library of 5900 and 51000 samples available from your dealer but these sounds can be personalised to your own tastes and then expanded even further using some of the techniques outlined above.

5950 - SPECIFICATIONS

System: Digital sampling (12-bit sampling/16-bit processing)
Sampling rate: 7.5kHz - 48.0kHz (continuously variable)
Bandwidth: 3kHz - 19.2kHz (continuously variable)
Sampling time: 9.89 sets - 03.3 sees
Polyphony: 8 Voice
Data storage: 3.5 inch disk drive (DD and HD disks)
Internal memory: 750k Byte
Max number
of samples: 99
Max number of
programs: 99

Editing facilities:

Sample: Select, copy, rename, delete
Replay mode Cone shot, looping, alternating)
Start point (with AUTO START POINT LOCATE)
End point
Loop length (with AUTOLC!OP function)
Crossfade looping
Resample at half bandwidth
Discard before start/after end
Sample crossfade/splice
Timestretch Cup to 999%)
Transpose, tune and loudness

Program: Select, copy, rename, delete
Individual keygroup copy, delete
PUT/GET function allows keygroups to be copied from
other programs
Velocity switching with variable switch value
Positional crossfade
Individual keygroup control of loudness, filter, transpose
and fine tune
Individual filter ADSR envelope generator per keygroup
Individual amplitude ADSR envelope generator per keygroup
Individual LFO control per keygroup
Mod wheel and aftertouch control of LFO
Warp - automatic pitchbend per keygroup (with velocity
control)
Individual keygroup velocity control of loudness, filter
ADSR attack time, ADSR release time
Individual keygroup control of filter track, constant
pitch (keyboard on/off)
Individual keygroup assignment to outputs
Individual MIDI assignment per keygroup

Other: Akai ME35T audio/pad-MIDI converter control
Master tune

Outputs: Mono mix, left and right, 8 individual assignable outputs
Inputs: Mic, Line
Other: MIDI IN, OUT and THRU. RS232 or equivalent
Record.trigger in

Options: Memory expansion board (EXM006> X 2
Atari/Supra-CD/RDAT hard disk and digital audio interface

Dimensions: 482.6CW) X 132.6(H) X 410 <D>mm <EIA rack mount - 3U>
Weight: 10.8kg

MIDI DIGITAL SAMPLER
Nodes 5950 MIDI Implementation Chart

J

Function ...	Transmitted	Recognized	Remarks
Basic Default ~ Channel Changed ~	X x	1 1 - 16	without Disk blemorized(Disk k)
Default ~ Mode Messages Altered	x X	Mode 1 Mode 1 - 4 Omni on/off.P/?1 x	Without Disk Nemorized(Disk)
Note Number : True voice	x	0 - 127 24 - 96	
Velocity Note ON Note OFF	X	Q 9n V-I^-127 Q 9n V-0 or 8n V-0^-127	used Velocity release
After Key's Touch Ch's	X x	x Q	
Pitch Bender	X ~	Q	0-12: Half tone step (7 bit)
Control 1 Change 64	x x	0 o	Modulation heal Damper pedal
Prog Change : True #	X	1 ^-127 1 127	by Preset num- ber value
System Exclusive	Q	Q	ID:47
System : Song Pos Song Sel Common : Tune	X X x	X x x	
System :Clock Real Time - :Commands	x X	x X	
Aux :Local ON/OFF :All Notes OFF Mes° :Active Sense sages: Reset	x x X X	X Q (123) X x	
Notes			

Mode 1 : OMNI ON, POLY Mode 2 : OMNI ON. MONO
Mode 3 : OMNI OFF. POLY
: OMNI OFF. MONO X : no

Q : Yes
Mode 4

WHAT IS SAMPLING'

Sampling is a method of digital recording but, unlike digital tape recorders, a sampler can only record a short amount of sound. Basically, a sampler is a bit like a movie camera. As you know, a movie camera does not take one continuous photograph of a moving object but takes a whole pile of snapshots which, when played back at the right speed, gives the illusion of motion. Similarly with sampling. When you sample a sound, it takes a series of digital audio 'snapshots' which are then stored in computer memory. These snapshots have to be taken because computers (which is what a sampler is) can only deal in absolute numbers whereas sound is continuously variable. When you sample something into your 5950, you actually digitise the sound using a device known as an ANALOGUE TO DIGITAL CONVERTER or ADC *which converts* the continuously variable waveform into a digital stepped waveform with each of the steps being one snapshot (see Fig. 1>.

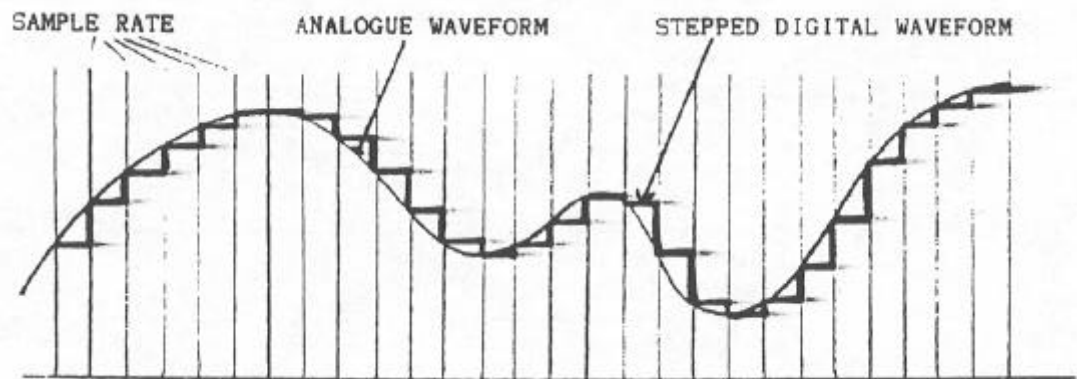

FIG. 1. Digitising an analogue waveform

Probably the most important factor with sampling is the sampling rate as this decides the BANDWIDTH or the audio quality. The sampling rate has to be very fast in order to faithfully reproduce the sampled sound. Going back to the movie camera analogy, you will remember that in the early days of silent films, the movements always seemed perky. This is because the speed of the camera was not fast enough to capture every single movement and when it played the film back, the result was that ,perky, stuttered motion. Nowadays, camera speed is a lot faster so movement seems smooth and natural. Similarly with samplers - if you don't have a fast enough sampling rate, the resultant sound will be distorted and lacking in higher frequencies and so will sound muffled. There will also be digital noise present in the signal (known as ALIASING) and the results will not bear much relationship to the original sound you sampled. If you compare Fig. 2 with Fig. 1 you will see why ° Fig. 2 with the low sampling rate doesn't look anything like the incoming signal whereas Fig. 1 with the faster sampling rate is a lot more accurate. In order for the sound in Fig. 2 to sound half decent, heavy filtering has to be used which will get rid of the distortion and digital noise but this will also produce a more muffled tone as it will remove the higher frequency **component** of the sound even further.

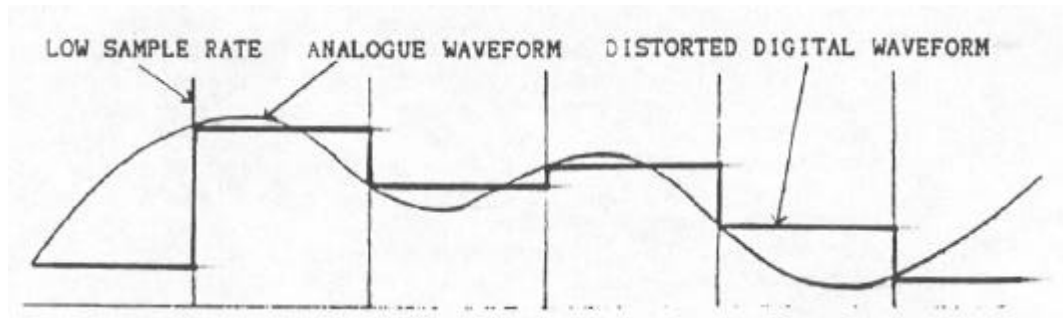

FIG. 2. Digitising an analogue waveform with a low sampling rate

But this needn't concern you too much because you can rest safe in the knowledge that the 5950's sampling rate is up there with the big boys sampling away at 48kHz giving you a maximum bandwidth of 19.2kHz - it's only when you want to sample longer sounds that you may have to compromise on audio quality by bringing the sampling rate down and hence the bandwidth. Even when you do this, you'll be surprised how good the 5950 sounds even with a bandwidth as low as 10kHz. Also, the sampling rate (and hence bandwidth) on the 5950 is continuously and totally variable and this allows you to maximise the sample memory. For example, say you were sampling a drum kit. The cracky snare would need a bandwidth of around 16kHz as would the hi-hats whilst the cymbals may require an even ,higher bandwidth - maybe 18-19kHz. The kick or bass drum, on the other hand, could get away wits a bandwidth of around 10kHz whilst the toms could still sound good.at a bandwidth of 12-i4kHz. In this way, you can sample sounds. with the optimum bandwidth and make more economical use of the 5950's sample memory.

So, once you taken this series of digital snapshots of the sound, what then? Well, each step of the digitised waveform is given a number so-that the computer can understand what it's dealing with and held in RANDOM ACCESS MEMORY or RAM. The more bits your sampler has, the more numbers the computer can assign to these steps and with more numbers, you can take more snapshots and so increase dynamic range, audio quality and/or sampling time even further.

The trouble is, those numbers mean nothing to us so they have to pass through a thing known as a DIGITAL TO ANALOGUE CONVERTER or DAC and here the digital sound is reconstituted into a continuous signal again and we hear the resulting sound. Fig. 3 shows a simplified layout of the 5950.

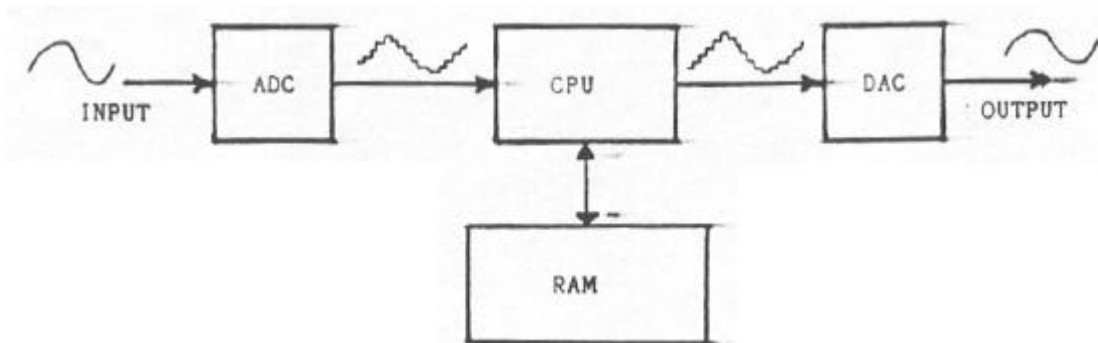

FIG. 3. Simplified layout of 5950

So, once those numbers are in the sampler, you can EDIT the sample. Here, you can instruct the computer to mess around with the data rather like you can use a word processor to edit text. The most basic thing you tell it to do is to actually play the sound.

Let us imagine that we have taken a one second sample at a bandwidth of 16k to give us a sample that is 39,900 of these digital numbers long, when you play a note on your MIDI controller, the- computer reads out the numbers from 1 to 39,900 from the RAM - the stream of numbers is then fed through the DAC and we hear the sound. If we tell the computer to read out those numbers at a faster speed - the sound will be higher in pitch. Similarly, if we tell the computer to read out those numbers slower, the sound will be lower in pitch. Now then, you could also instruct the computer to read those numbers out from 39,900 down to 1 - in other words, the sound will come out backwards.

But we have a problem here with this sample we have just taken because someone in the background coughed just before the sound and then laughed dust after the sample was taken. Well, you could instruct the computer to read out only numbers 3,000 to 27,350 - now you won't hear the cough at the start or the laugh at the end of the sample ° you have just edited the start and end points of the sample.

But we have another problem now.. This one second sample only lasts half a second when you play it an octave up so you can tell the computer to read out those numbers from 3,000 to 27,350 but then, when it has finished doing that, to read out numbers 25,180 to 27,350 over and over and over again for as long as you keep your finger on the keyboard ° you have just looped a sample so that it sustains for as long as you hold a key down. If the loop sounds a bit odd and full of glitches and clicks, you can even tell the computer to help find a better loop point using an AUTOLOOP function.

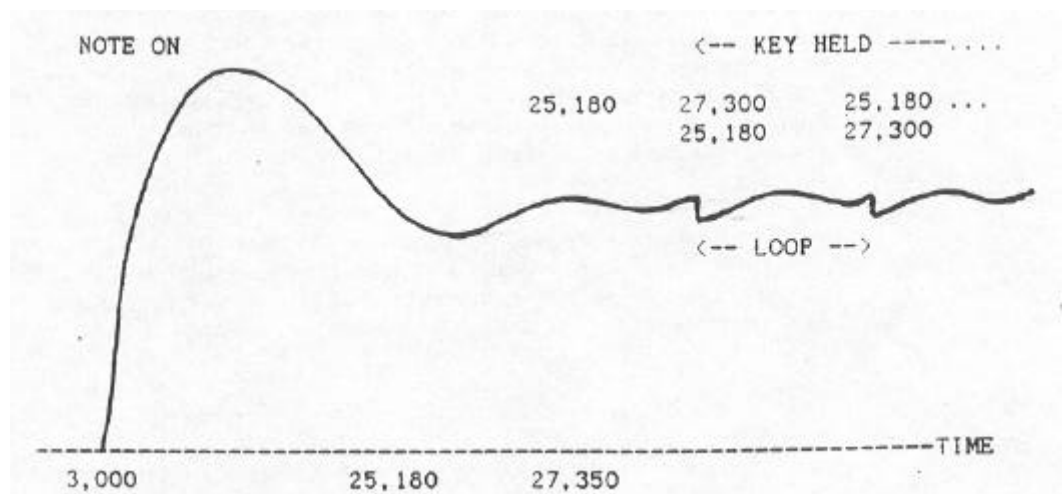

FIG. 3. Looping a sound

We do have another problem though:

You will notice that as you transpose the sample more than a few semitones up or down, the tonal characteristic starts to sound, well.. weird! This is especially true of voice samples where playing higher up the keyboard produces a sound not unlike some cheeky cartoon character whilst playing it lower on the keyboard, your voice sound like a space alien with indigestion! This happens because certain sounds have unique resonances in certain frequency ranges and these stay constant on the real thing. When you take one sample of such an instrument, those resonances are transposed with the sound and this gives the sound its unusual character. Of course, this side effect can be used to great creative effect and voice samples in particular can sound beautifully ethereal played high on the keyboard or disturbingly ominous when transposed down a few octaves. If you want to get round this problem, however, you will need to resort to MULTI-SAMPLING. This technique requires that you take a sample of the **instrument every few semitones** and then map these sounds across the keyboard so that, at any point, the transposition is never further than a few semitones away before the next sample is heard and so the resonances and tonal quality remain constant over the whole keyboard range (see Fig. 4). Instruments that need multisampling are things like pianos, strings, voices, guitars, oboes and clarinets amongst others but some sounds can get away with only one sample across the whole keyboard.

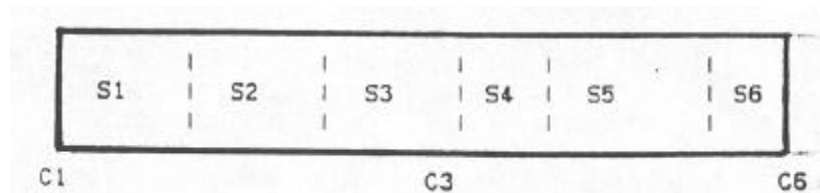

FIG. 4. Mapping samples (S1-S6) across the keyboard range

Having sampled your sounds and edited them and mapped them out across the keyboard it doesn't end there because once the signal goes through the DAC and is back in the analogue world, you can do some analogue things to it like shove it through filters and amplifiers. If you do that you can also add envelope shaping and generally treat your sampler like a synthesizer to radically transform the sound. You can also bring certain samples out of their own individual audio output so that they can be further modified on a mixer - all sorts of possibilities suddenly become available and one single sample can be the basis of any number of variations.

And that's it basically. Of course, it can get a lot more complex than that but hopefully, this should help you understand what is happening inside your 5950 every time you poke around in EDIT SAMPLE or EDIT PROGRAM or play a note on the keyboard.

WHAT IS MIDI?

Back in the early days of synthesizers, a system known as voltage control was used. Basically, when you played a note on the keyboard, you sent a voltage to voltage controlled oscillators and the value of that voltage determined the pitch of the oscillators. At the same time, the keyboard sent out a pulse (known as a trigger or gate pulse) to devices known as envelope generators which also produced a rising and falling voltage which would sweep through a voltage controlled filter and open and close a voltage controlled amplifier. A device known as a low frequency oscillator also generated rising and falling voltages and this could be routed to the oscillators, filter and/or amplifier for pitch, tonal and amplitude sweeps.

Most synths at that time were only monophonic - that is they could only play one note at a time and so it was easy thing to stick four sockets on the back of the synth. One socket had the keyboard voltage output, another had the gate pulse output whilst the other two sockets were for voltage and gate pulse inputs. Using these sockets, it was possible for one synth to play another and it all worked rather well. The problem was that different **manufacturers** used different methods of triggering the envelope generators and so, without using special interfaces, it was not possible to have a Moog synth playing a Roland or ARP synth or vice versa. Neither was it possible for a Korg synth to play a Moog or a Sequential synth. This was also true with the simple sequencers that were around in those days and, similarly, it was not possible to use a Moog sequencer with anything other than Moog equipment - likewise with Korg.

This problem was further complicated with the advent of polyphonic synths such as the Prophet 5, Oberheim OBX and Roland Jupiter 8 and complicated even further with the advent of digitally controlled synthesizers.

In 1983, Dave Smith, president of Sequential Circuits, put forward a proposal to the Audio Engineering Society (AES) which suggested that as most manufacturers were using microprocessors at the heart of their synths, sequencers and drum machines, a standard digital interface could be used that allowed any manufacturers equipment to be used with another with no interfacing problems. The Musical Instrument Digital Interface or MIDI had been born and over the following few years, the specification of MIDI changed quite radically to the powerful interfacing system it is today. But what is MIDI?

MIDI is basically a digital communication system. At the heart of every synth, sampler, drum machine and sequencer is a microprocessor. By getting the microprocessor from one instrument to directly 'talk' to another instrument's microprocessor it is possible to play the two instruments as if they were one. The most basic use of this is to layer two instruments sounds on top of each other to create a richer, bigger sound.

If you refer to Fig. 1, you can see the layout of a typical synth or sampler. As you can see, at the heart of this is the microprocessor or Central Processing Unit (CPU) and this is controlling practically every aspect of the instrument from keyboard control to sound editing - some even allow sequencing and other facilities. Observe the position of the MIDI outputs. If the MIDI OUT is taken to the MIDI IN of another instrument, anything you do on the controlling synth is duplicated on the other.

For example, play a note on the keyboard and the other instrument will play that same note. Use the pitch bend wheel or modulation wheel and the other synth will also respond. Furthermore, select a different sound on the controlling synth and the other synth will change its sound also. Of course, sometimes this is not always desirable and so it is possible to switch off certain MIDI functions if you wish.

This is MIDI at its simplest and allows you layer two or more synths to create a richer sound.

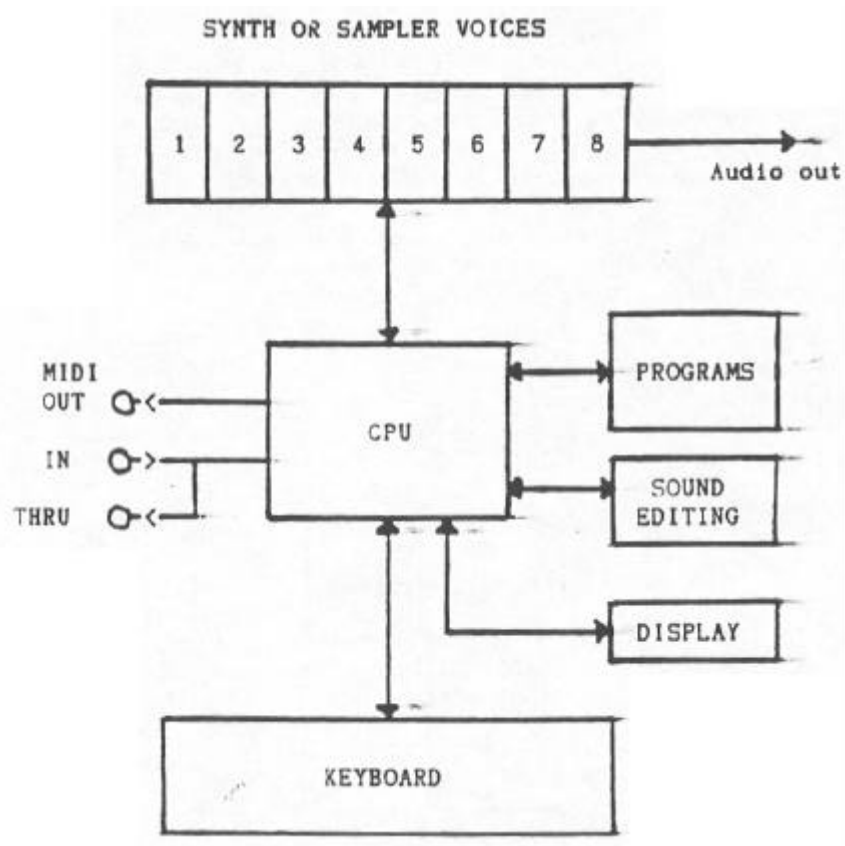

FIG. 1. Simplified layout of a typical synth or sampler

But there is more to MIDI than dust layering synths and samplers together.

For example, there are 16 different MIDI channels you can work on. You can think of this rather like a TV set. This too has a number of channels and coming down the aerial are all the TV channels simultaneously and you simply select which channel you want to watch on the TV using the channel select button. Similarly with MIDI. Going down the 5 pin MIDI lead are all 16 MIDI channels and you have to select which channel you want your synth to receive. For example, if synth 1 is transmitting MIDI channel 3, then synth 2 must be set up to receive MIDI channel 2 otherwise it won't sound. Having said that, there is a MIDI mode known as OMNI ON which sets your synth or sampler to receive MIDI on all channels so it is not always necessary to match your instruments MIDI channels up and some instruments default to OMNI ON when you switch it on.

But why have 16 MIDI channels? Well, the real power of MIDI is in sequencing. A sequencer can record MIDI information on all 16 MIDI channels and it is possible for a sequencer to record a drum part on MIDI channel 1, a bass part on MIDI channel 2, a piano part on MIDI channel 3, a string part on MIDI channel 4, a brass part on MIDI channel 5 with maybe a leadline melody on MIDI channel 6. All these parts could be sent down the MIDI lead to a variety of synths and samplers and each instrument would play its own part with its own sound on its own MIDI channel. As you can imagine, this can get quite expensive having 5 or 6 or more synths or samplers lying around so a lot of synth and sampling modules and keyboard synths can be MULTI-TIMBRAL - that is, each of their voices can be set up to receive a different MIDI channel and play a different sound. This can be as many as 8 whilst some allow the maximum of 16. Of course, when sequencing like this, none of the synths must be set to OMNI ON otherwise they will play ALL the parts thrown at it!!

So now we know about the MIDI IN and the MIDI OUT and MIDI channels, what about the MIDI THRU socket?

This socket is simply a parallel tap of anything coming in through the MIDI IN and you can 'daisy chain' any number of synths by connecting them- to MIDI THRU as in Fig. 2a. Having said that, connecting a whole pile of synths, samplers or drum machines using only MIDI THRU could give rise to slight delays so it is best to use a MIDI THRU box such as the Akai ME30P11 Programmable MIDI Patchbay and connect the equipment as shown in Fig. 2b. This will stop any delays as well as allowing you to patch any instrument to any instrument at any time.

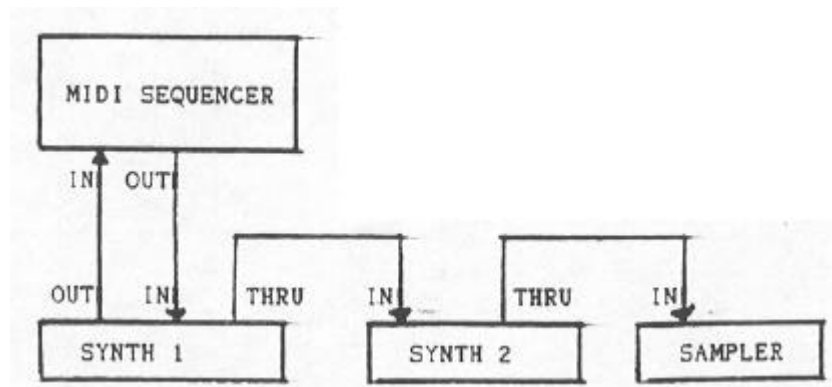

FIG. 2a Connecting a MIDI sequencer to MIDI synths using MIDI THRU

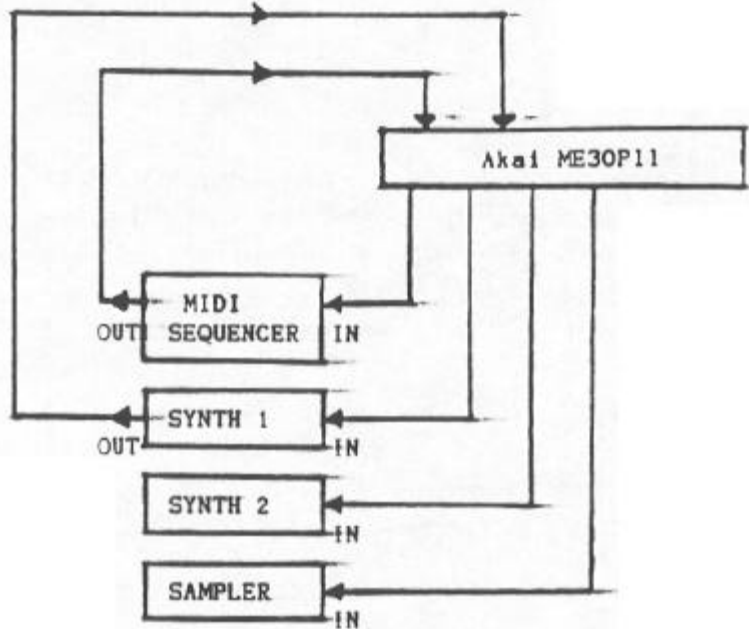

FIG. 2b Connecting a MIDI sequences to MIDI synths using the Akai ME30PI1

But there is even more to MIDI than that. At its simplest level, you can layer one instrument on top of another to create a richer sound. At a slightly higher level, you can use a sequences to control as many as 16 synths or samplers and to synchronise drum machines where each instrument plays a different musical part. There's an even higher level known as SYSTEM EXCLUSIVE.

If MIDI is a universal Interfacing language, System Exclusive is not. Basically, there is room in the MIDI specification for each manufacturer to have their own personal identification code so that all the equipment they make can talk to each other on a much higher level. This sort of thing is useful for remotely programming one synth from another or for dumping sounds from one synth or sampler to another so long as they ere made by the same manufacturer. System Exclusive, therefore, allows each manufacturer to use MIDI for their own purposes independently of the main MIDI specification.

The world of modern music is very exciting right now. It's not only synths that have microprocessors In them but reverb, other effects devices and mixers also have them so, using MIDI, It is possible to have your keyboard controlling them as well - using a sequences synchronised to a timecode on a mufti-track tape, it is possible to run the mufti-track with acoustic instruments and vocals and have as many as sixteen or more sequenced synths, samplers and modules being mixed in 'live' whilst the sequences also controls effects switching AND the mix levels for a fully automated mixdown.

The older synths with their voltage control were good, but they weren't that good!!

ADDENDUM FOR S950 MANUAL

The 5950 is not capable of recognizing sounds that were defined as soft samples on an 5950 (i.e. any samples that have the "j<" symbol after the sample name). What happens is that the S950 places the start point at the end of a soft sample so that it cannot be heard. This is not a fault of the 5950 and your 5950 or disk is not defective in any way.

To rectify this, go to EDIT SAMPLE and select the soft sample (i.e. GTR DI X) and go to the "EDIT START POINT" page. Now change the start point so that the display reads 0000 - you will now hear the sample. Having done that, repeat the process for other soft samples and save the edited sample(s) to an 5950 formatted disk. You may also choose to rename the sample(s) if you wish.

You can now select the velocity switch program(s) and hear both the loud and the soft samples depending on how hard you strike the keyboard.

ADDENDUM TO THE OWNER'S MANUAL

AKAI S900 DIGITAL SAMPLER

INITIATING SAMPLE DUMP FROM THE FRONT PANEL OF
THE S900

A feature of the S900 which is not covered in the owner's manual is its ability to send and receive samples through MIDI. This will allow you to transfer sounds from one sampler to another device (sampler, computer, etc.) directly through the MIDI interface, instead of sampling the audio output.

Note: The S900 does **not support the MIDI Sample Dump Standard (SDS)**. Instead, it uses a version of sample dump protocol which was set up before SDS became an part of the official MIDI specification. Therefore, the S900 cannot directly send or receive samples to/from other samplers which do use SDS. The S900 can directly communicate with the Akai S700, X7000, and S950 samplers, as they share the same sample dump implementation.

If the S900 receives a dump request message from another unit, it will begin sending the requested sample. Please refer to the MIDI System Exclusive documentation for the S900 for details on the specific commands which are necessary (available from IMC at the address below). However, if you should want to initiate the sending of a sample .using the front panel controls of the S900, here's how to do it:

(1) Press "Edit Sample". Select the sample you wish to send.

(2) Simultaneously press the "0", "On", and "Off" buttons in the keypad. When you do this, the screen will still appear the same, but the light over the Edit Sample button will no longer be flashing (it might be on or off, but not flashing on and off).

(3) Press the "Page Down" button (the one on the right, pointing down). The display will change to read "Sending Sample xxx Over MIDI", where xxx is the selected sample's name. When the sample dump is complete the display will return to the normal Sample Edit Page #1, but you need to do one more thing to return to regular operation:

(4) Press the "ENT" button. Now you can select another sample to send and

AKAI |
professional